

























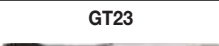


## Tapping

Tapping Introduction.....	X2–X9
Spiral-Point/Left-Hand Spiral-Flute Taps.....	Y2–Y17
Spiral-Flute Taps .....	Y18–Y42
Straight-Flute Taps.....	Y44–Y56
Forming Taps.....	Y58–Y63
Thread Mills.....	Y64–Y83
High-Performance Taps Application Data .....	Y84–Y86
Technical Information .....	Y88–Y115

★ Good ★★ Better ★★★ Best	hole		thread		coolant		size range min-max	grade/ coating	material				chamfer		helix angle	dimension
	through	blind	cutting	forming	flood	through			carbide	HSS-E-PM	HSS-E	HSS	type	form		
<b>Spiral-Point and Left-Hand Spiral-Flute Taps</b>																
GT20	X		X		X		M3-M42	GP6520, GM6515	X				plug	D	L15°	DIN 371, 374, 376
GT20	X		X		X		M24-M42	GP6520	X				plug	D	L15°	DIN 376, XL
GT21	X		X			X	M5-M14	GP6520, GM6515	X				plug	D	L15°	DIN 371, 376
GT10	X		X		X		M3-M20	WS32MG	X				plug	D	L8°	DIN 371, 376
GT14	X		X		X		M3-M12	WN35MG	X				plug	B	0°	DIN 371, 376
GT70	X		X		X		M3-M16	WN48EG	X				plug	B	0°	DIN 371, 376
GT00	X		X		X		M3-M20	WP31MG	X				plug	B	0°	DIN 371, 374, 376
VTSP060	X		X		X		#4-1"	WP49EG, WU41EG		X			plug	B	0°	DIN 371, 376
VTSP065	X		X		X		M2-M36	WP42EG, WU41EG, WP49EG, WU40EG		X			plug	B	0°	DIN 371, 374, 376
VTSP075	X		X		X		M3-M20	WU41EG, WU40EG		X			plug	B	0°	JIS
<b>Spiral-Flute Taps</b>																
GT30		X	X		X		M24-M42	GP6520	X				semi-bottom	C	45°	DIN 376, XL
GT30		X	X		X		M3-M42	GP6520, GM6515, GP6505	X				semi-bottom	C	45°	DIN 371, 374, 376
GT31		X	X			X	M5-M42	GP6520, GM6515	X				semi-bottom	C	45°	DIN371, 376
GT31		X	X			X	M24-M42	GP6520	X				semi-bottom	C	45°	DIN 376, XL
GT32		X	X		X		M5-M16	GP6520	X				bottoming	E	45°	DIN 371, 374, 376
GT33		X	X			X	M5-M16	GP6520	X				bottoming	E	45°	DIN 371, 374, 376
GT50		X	X		X		M24-M42	GP6520	X				semi-bottom	C	15°	DIN 376, XL
GT51		X	X			X	M24-M42	GP6520	X				semi-bottom	C	15°	DIN 376, XL
GT12		X	X		X		M3-M20	WS32MG	X				semi-bottom	C	10°	DIN 371, 376
GT16		X	X		X		M3-M12	WN35MG	X				semi-bottom	C	30°	DIN 371
GT80		X	X		X		M3-M20	WN48EG	X				semi-bottom	C	45°	DIN 371, 376

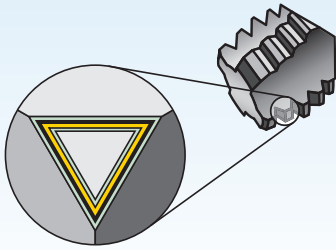
		P				M	K		N			S				H		page(s)	recommended cutting parameters
		1, 2, 3, 4, 6, 7	5, 9, 10, 11	12, 13.1	13.2	14.1, 14.2, 14.3, 14.4	15, 16	17, 18, 19, 20	21	22, 23, 24, 25	26, 27, 28	31, 32	33, 34, 35	36	37	38.1, 38.2, 40.1, 40.2, 41.1	39.1, 41.2		
		Steel <35 HRC	Steel >36-48 HRC	PH and Ferritic Stainless Steel <35 HRC	PH and Ferritic Stainless Steel >35 HRC	Stainless Steel	Grey Cast Iron	Ductile Cast Iron	Wrought Aluminium	Cast Aluminium	Copper, Copper Alloys	Iron Based	Cobalt Based	Nickel Based	Titanium Alloys	Hardened Steels 49-55 HRC	Hardened Steels 56-68 HRC		
<b>Spiral-Point and Left-Hand Spiral-Flute Taps (continued)</b>																			
	***		***		***		**	*	*		**						Y4	Y85	
	***		***		***		**	*	*		**						Y5	Y85	
	***		***		***		**	*	*		**						Y6	Y85	
												***	***				Y7	Y85	
														***			Y8	Y85	
								***	*	*							Y9	Y85	
		***		***	*	*	*						*				Y10	Y85	
	**	*	*		**	*	**	*	**	**	*						Y11	Y86	
	**	*	*		**	*	**	*	**	**	*						Y14	Y86	
	**	*	*		**	*	**	*	**	**	*						Y17	Y86	
<b>Spiral-Flute Taps (continued)</b>																			
	***		***		***		**	*	*			**					Y21	Y85	
	***		***		***		**	*	*			**					Y20	Y85	
	***		***		***		**	*	*			**					Y22	Y85	
	***		***		***		**	*	*			**					Y23	Y85	
	***		***		***		**	*	*			**					Y24	Y85	
	***		***		***		**	*	*			**					Y25	Y85	
	***		***				**										Y26	Y85	
	***		***				**										Y28	Y85	
												***	***				Y30	Y85	
														***			Y31	Y85	
								***									Y32	Y85	

★ Good ★★ Better ★★★ Best	hole		thread		coolant		size range min-max	grade/ coating	material				chamfer		helix angle	dimension
	through	blind	cutting	forming	flood	through			carbide	HSS-E-PM	HSS-E	HSS	type	form		
																
<b>Spiral-Flute Taps (continued)</b>																
		X	X		X		M3-M20	WP31MG	X				semi-bottom	C	25°	DIN 371, 374, 376
		X	X		X		M3-M20	WH36MG	X				semi-bottom	C	42°	DIN 371, 374, 376
		X	X		X		#4-1"	WP49EG, WU41EG		X			semi-bottom	C	45°	DIN 371, 376
		X	X		X		M2-M36	WP42EG, WU41EG, WP49EG, WU40EG		X			semi-bottom	C	45°	DIN 371, 374, 376
		X	X		X		M3-M20	WP49EG, WP42EG		X			bottoming	E	45°	DIN 371, 374, 376
		X	X		X		M3-M20	WU41EG, WU40EG		X			semi-bottom	C	45°	JIS
<b>Straight-Flute Taps</b>																
	X	X	X		X		M3-M16	WH16PG	X				semi-bottom	C	0°	DIN 371, 374, 376
		X	X			X	M6-M16	WK12PG	X				bottom	E	0°	HA6535
		X	X			X	M6-M14	WK12PG	X				bottom	E	0°	DIN 371, 374, 376
		X	X			X	M6-M10	WN14PG	X				bottoming	E	0°	DIN 371
		X	X			X	M6-M16	WN14PG	X				bottom	E	0°	HA6535
		X	X			X	M4-M14	WK12PG	X				semi-bottom	C	0°	DIN 371, DIN 376
	X	X	X		X		M4-M22	GP6520	X				semi-bottom	C	0°	DIN 371, 374, 376
	X	X	X			X	M4-M20	GP6520	X				semi-bottom	C	0°	DIN 371, 374, 376
		X	X		X		M5-M20	GP6520	X				bottoming	E	0°	DIN 371, 374, 376
		X	X			X	M5-M20	GP6520	X				bottoming	E	0°	DIN 371, 374, 376
	X	X	X		X		M6-M16	WS32MG	X				semi-bottom	C	0°	DIN 371, 374, 376
<b>Form Taps</b>																
		X		X		X	M6-M10	WN14PG	X				bottoming	E	—	DIN 374
		X		X		X	M6-M12	WN14PG	X				bottoming	E	—	HA6535
	X	X		X	X		M3-M16	WP31MG, WN38MG	X				semi-bottom	C	—	DIN 2174
	X	X		X		X	M5-M16	WP31MG, WN38MG	X				semi-bottom	C	—	DIN 2174

P				M	K		N			S				H		page(s)	recommended cutting parameters
1, 2, 3, 4, 6, 7	5, 9, 10, 11	12, 13.1	13.2	14.1, 14.2, 14.3, 14.4	15, 16	17, 18, 19, 20	21	22, 23, 24, 25	26, 27, 28	31, 32	33, 34, 35	36	37	38.1, 38.2, 40.1, 40.2, 41.1	39.1, 41.2		
Steel < 35 HRC	Steel > 36-48 HRC	PH and Ferritic Stainless Steel < 35 HRC	PH and Ferritic Stainless Steel > 35 HRC	Stainless Steel	Grey Cast Iron	Ductile Cast Iron	Wrought Aluminium	Cast Aluminium	Copper, Copper Alloys	Iron Based	Cobalt Based	Nickel Based	Titanium Alloys	Hardened Steels 49-55 HRC	Hardened Steels 56-68 HRC		
<b>Spiral-Flute Taps (continued)</b>																	
	★★★		★★★	★	★	★										Y33	Y85
	★★★		★★★													Y34	Y85
★★	★	★		★★	★	★★	★	★★	★★	★						Y35	Y86
★★	★	★		★★	★	★★	★	★★	★★	★						Y38	Y86
★★	★	★		★★	★	★★	★	★★	★★	★						Y41	Y86
★★	★	★		★★	★	★★	★	★★	★★	★						Y42	Y86
<b>Straight-Flute Taps (continued)</b>																	
															★★★	Y46	Y84
					★★★	★★★										Y47	Y84
					★★★	★★★										Y48	Y84
								★★★								Y49	Y84
								★★★								Y50	Y84
					★★★	★★★										Y51	Y84
					★★★	★★★		★★★	★★							Y52	Y85
					★★★	★★★		★★★	★★							Y53	Y85
					★★★	★★★		★★★	★★							Y54	Y85
					★★★	★★★		★★★	★★							Y55	Y85
														★★★	Y56	Y85	
<b>Form Taps (continued)</b>																	
							★★★	★★								Y60	Y84
							★★★	★★								Y61	Y84
★★★							★★★	★★								Y62	Y85
★★★							★★★	★★								Y63	Y85

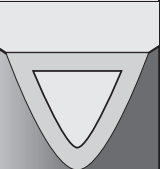
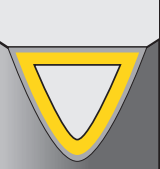
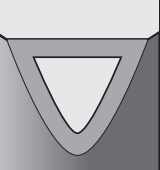
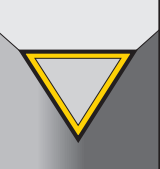
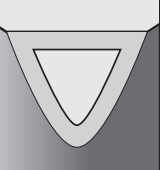






Coatings are designed for optimised tapping performance in specific materials.

<b>P</b>	Steel
<b>M</b>	Stainless Steel
<b>K</b>	Cast Iron
<b>N</b>	Non-Ferrous
<b>S</b>	High-Temp Alloys
<b>H</b>	Hardened Materials

		wear resistance ← → toughness										
Coating	Grade Description	05	10	15	20	25	30	35	40	45		
Grade WN32MG	 <p>Coated HSS-E-PM, PVD heat- and wear-resistant high-vanadium cobalt powder metal HSS substrate with high-hardness TiCN coating. Use when tapping heat-treated steel 44-55 HRC and cobalt- or nickel-based heat-resistant alloys.</p>											
WN35MG	 <p>Coated HSS-E-PM, PVD powder metal HSS-E substrate with two-layer coating. TiN base layer and DLC top layer that resists galling of non-ferrous materials to the tap. Use for tapping titanium. Not recommended for steel.</p>											
WN38MG	 <p>Coated HSS-E-PM, PVD powder metal HSS-E substrate with DLC coating. Use for form tapping aluminium. Not recommended for steel.</p>											
WN44EG	 <p>High-vanadium HSS-E substrate with a coating consists of low friction CrC/C over wear-resistant TiN base layer. Use for tapping stainless steel and non-ferrous materials.</p>											
WP42EG	 <p>Coated HSS-E substrate with TiCN PVD layer. Use in multiple applications, including steel, stainless steel, ductile cast iron, and cast aluminium. WP42EG is more abrasion-resistant than WU41EG.</p>											







## Tapping Portfolio

<b>Spiral-Point and Left-Hand Spiral-Flute Taps .....</b>	<b>Y2–Y17</b>
High-Performance Victory HSS-E-PM Taps .....	Y4–Y10
Multipurpose VariTap .....	Y11–Y17
<b>Spiral-Flute Taps .....</b>	<b>Y18–Y42</b>
High-Performance Victory HSS-E-PM Taps .....	Y20–Y34
Multipurpose VariTap .....	Y35–Y42
<b>Straight-Flute Taps.....</b>	<b>Y44–Y56</b>
High-Performance Victory Solid Carbide Taps .....	Y46–Y51
High-Performance Victory HSS-E-PM Taps .....	Y52–Y56
<b>Forming Taps.....</b>	<b>Y58–Y63</b>
High-Performance Victory Solid Carbide Taps .....	Y60–Y61
High-Performance Victory HSS-E-PM Taps .....	Y62–Y63
<b>Thread Mills.....</b>	<b>Y64–Y83</b>
<b>High-Performance Taps Application Data .....</b>	<b>Y84–Y86</b>
<b>Technical Information .....</b>	<b>Y88–Y115</b>

Solutions for Through Hole Applications •

**WIDIA-GTD™**

# Spiral-Point and Left-Hand Spiral-Flute



WIDIA-GTD™ offers a wide range of options for tapping through holes in:

- Steel and steel alloys.
- Stainless steel.
- Cast iron.
- Wrought and cast aluminium.
- Nickel-based alloys.
- Titanium alloys.

## High-Performance Victory™ HSS-E-PM Taps

- Left-hand spiral flutes to push chips ahead in through holes.
- Manufactured from powdered metal high-speed steel coated for thread cutting in various applications.
- Offer performance advantages over conventional high-speed steel taps.
- Long tap life at up to 50% higher tapping speed than HSS taps.
- PVD coatings offer outstanding thermal stability, hot hardness, oxidation resistance, and low coefficient of friction.
- Low runout of thread and chamfer.
- Excellent chip control.
- Reliable performance.
- Exceptional thread quality.

## Multipurpose VariTap™

- Unique spiral-point geometry provides low tapping torque while pushing chips ahead of the tap in through holes.
- Manufactured from high-vanadium HSS-E to provide long and consistent life.
- Ideal for customers who have a variety of materials to machine.
- Geometry designed to allow tapping of a wide variety of ductile materials: carbon and alloy steels, stainless steels, ductile iron, and cast aluminium.
- Wide range of inch and metric standard sizes, pitch diameter limits, classes of fit, chamfer styles, and coatings.

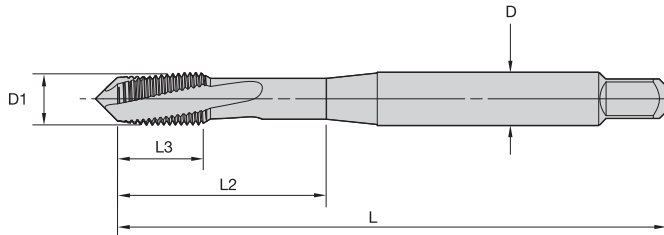


**WIDIA**  
**VICTORY**

# High-Performance Taps

Victory™ Left-Hand Spiral-Flute HSS-E-PM Taps • Through Holes

- GM6515 TiN + CrC/C for stainless steel.
- GP6520 TiCN for steel.

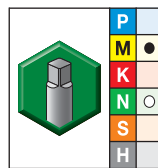
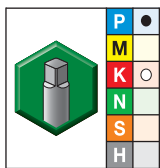


Shank Tolerance

D mm	tolerance h6
>3-6	+0, -0,008
>6-10	+0, -0,009
>10-18	+0, -0,011
>18-30	+0, -0,013
>30-50	+0, -0,016



■ GT20 • Form D Plug Chamfer • Metric DIN 371, 374, and 376 • For Steel and Stainless Steel

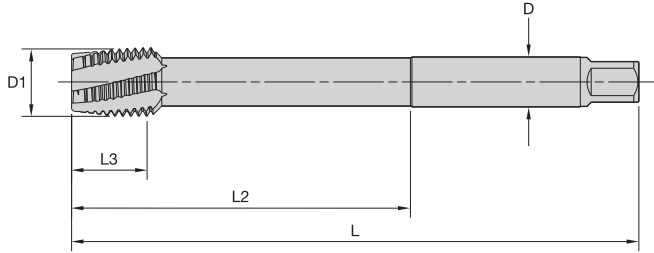


- first choice
- alternate choice

grade GP6520 TiCN		grade GM6515 TiN+CrC/C		metric dimensions					number of flutes	dimension standard	class of fit
order #	catalogue #	order #	catalogue #	D1 size	L	L3	L2	D			
3955084	GT205094	3955047	GT205077	M3 X 0,5	56	8	18	3,5	2	DIN 371	6HX
3955085	GT205095	3955048	GT205078	M4 X 0,7	63	10	21	4,5	2	DIN 371	6HX
3955086	GT205096	3955049	GT205079	M5 X 0,8	70	10	25	6,0	2	DIN 371	6HX
3955087	GT205097	3955050	GT205080	M6 X 1	80	10	30	6,0	3	DIN 371	6HX
3955124	GT205104	3955077	GT205087	M8 X 1	90	13	35	6,0	3	DIN 374	6HX
3955088	GT205098	3955051	GT205081	M8 X 1,25	90	13	35	8,0	3	DIN 371	6HX
3955125	GT205105	3955078	GT205088	M10 X 1	90	10	35	7,0	3	DIN 374	6HX
3955126	GT205106	3955079	GT205089	M10 X 1,25	100	15	39	7,0	3	DIN 374	6HX
3955089	GT205099	3955052	GT205082	M10 X 1,5	100	15	39	10,0	3	DIN 371	6HX
3955127	GT205107	3955080	GT205090	M12 X 1,5	100	15	39	9,0	3	DIN 374	6HX
3955090	GT205100	3955073	GT205083	M12 X 1,75	110	18	44	9,0	3	DIN 376	6HX
3955128	GT205108	3955081	GT205091	M14 X 1,5	100	15	47	11,0	4	DIN 374	6HX
3955091	GT205101	3955074	GT205084	M14 X 2	110	20	52	11,0	4	DIN 376	6HX
3955129	GT205109	3955082	GT205092	M16 X 1,5	100	15	46	12,0	4	DIN 374	6HX
3955092	GT205102	3955075	GT205085	M16 X 2	110	20	51	12,0	4	DIN 376	6HX
3955130	GT205110	3955083	GT205093	M18 X 1,5	110	15	50	14,0	4	DIN 374	6HX
3955123	GT205103	3955076	GT205086	M20 X 2,5	140	25	64	16,0	4	DIN 376	6HX
4033723	GT205111	-	-	M24 X 3	160	30	77	18,0	5	DIN 376	6HX
4033725	GT205113	-	-	M30 X 3,5	180	35	91	22,0	5	DIN 376	6HX
4033726	GT205114	-	-	M33 X 3,5	180	35	100	25,0	5	DIN 376	6HX
4033728	GT205116	-	-	M36 X 4	200	40	110	28,0	6	DIN 376	6HX
4033730	GT205118	-	-	M42 X 4,5	200	45	120	32,0	6	DIN 376	6HX

High-Performance Taps

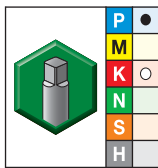
- GP6520 TiCN for steel and cast iron.



Shank Tolerance	
D mm	tolerance h6
12-18	+0, -0,011
20-30	+0, -0,013
32-36	+0, -0,016



- GT20 • Form D Plug Chamfer • Larger Sizes • Metric Extra Long • For Steel and Cast Iron



- first choice
- alternate choice

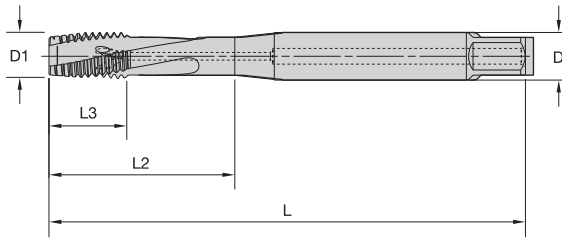
grade GP6520 TiCN		metric dimensions					number of flutes	class of fit
order #	catalogue #	D1 size	L	L3	L2	D		
4033765	GT205122	M24 X 3	200	30	120	18,0	5	6HX
4033767	GT205124	M30 X 3,5	250	35	150	22,0	5	6HX
4033768	GT205125	M33 X 3,5	250	35	150	25,0	5	6HX
4033770	GT205127	M36 X 4	250	40	150	28,0	6	6HX
4033772	GT205129	M42 X 4,5	300	45	180	32,0	6	6HX

# High-Performance Taps

Victory™ Left-Hand Spiral-Flute HSS-E-PM Taps • Through Holes



- GM6515 TiN + CrC/C for stainless steel.
- GP6520 TiCN for steel.

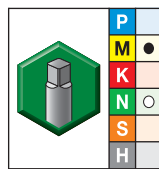
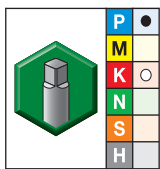


Shank Tolerance

D mm	tolerance h6
>3-6	+0, -0,008
>6-10	+0, -0,009
>10-18	+0, -0,011
>18-30	+0, -0,013
>30-50	+0, -0,016



■ GT21 • Form D Plug Chamfer • Through Coolant • Metric DIN 371 and 376 • For Steel and Stainless Steel

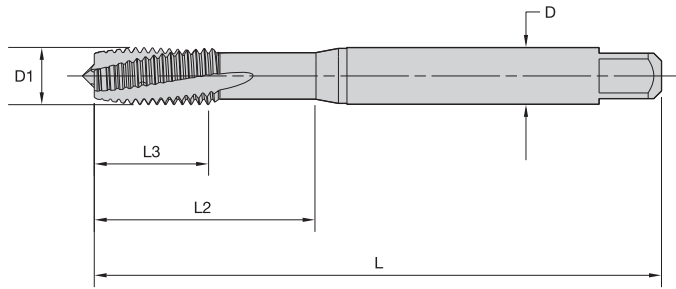


- first choice
- alternate choice

grade GP6520 TiCN		grade GM6515 TiN+CrC/C		metric dimensions					number of flutes	dimension standard	class of fit
order #	catalogue #	order #	catalogue #	D1 size	L	L3	L2	D			
3955054	GT215007	3955038	GT215001	M5 X 0,8	70	10	25	6,0	2	DIN 371	6HX
3955055	GT215008	3955039	GT215002	M6 X 1	80	10	30	6,0	3	DIN 371	6HX
3955056	GT215009	3955040	GT215003	M8 X 1,25	90	13	35	8,0	3	DIN 371	6HX
3955057	GT215010	3955041	GT215004	M10 X 1,5	100	15	39	10,0	3	DIN 371	6HX
3955058	GT215011	3955042	GT215005	M12 X 1,75	110	18	44	9,0	3	DIN 376	6HX
3955059	GT215012	3955053	GT215006	M14 X 2	110	20	52	11,0	4	DIN 376	6HX



- WS32MG TiCN for nickel and nickel alloys.

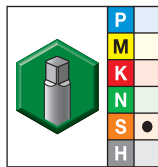


Shank Tolerance

D mm	tolerance h9
1-3	+0, -0,025
>3-6	+0, -0,030
>6-10	+0, -0,036
>10-18	+0, -0,043
>18-30	+0, -0,052



■ GT10 • Form D Plug Chamfer • Metric DIN 371 and 376 • For Nickel and Nickel Alloys



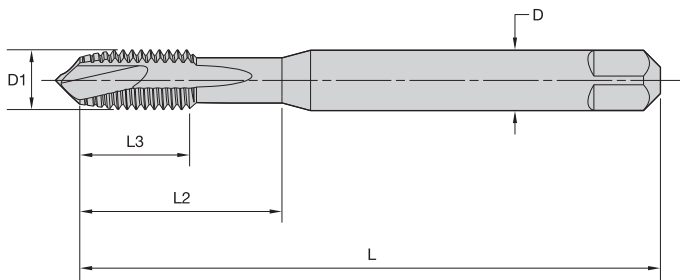
- first choice
- alternate choice

grade WS32MG TiCN		metric dimensions					number of flutes	dimension standard	class of fit
order #	catalogue #	D1 size	L	L3	L2	D			
4160100	GT105001	M3 X 0,5	56	11	18	3,5	2	DIN 371	6HX
4160101	GT105002	M4 X 0,7	63	13	21	4,5	3	DIN 371	6HX
4160102	GT105003	M5 X 0,8	70	15	25	6,0	3	DIN 371	6HX
4160103	GT105004	M6 X 1	80	17	30	6,0	3	DIN 371	6HX
4160104	GT105005	M8 X 1,25	90	20	35	8,0	3	DIN 371	6HX
4160105	GT105006	M10 X 1,5	100	22	39	10,0	3	DIN 371	6HX
4160106	GT105007	M12 X 1,75	110	24	—	9,0	3	DIN 376	6HX
4160107	GT105008	M14 X 2	110	26	—	11,0	3	DIN 376	6HX
4160108	GT105009	M16 X 2	110	27	—	12,0	3	DIN 376	6HX
4160109	GT105010	M20 X 2,5	140	32	—	16,0	3	DIN 376	6HX

# High-Performance Taps

Victory™ Spiral-Point Plug HSS-E-PM Taps • Through Holes

- WN35MG TIN/DLC for titanium and titanium alloys.

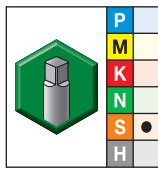


Shank Tolerance

D mm	tolerance h9
1-3	+0, -0,025
>3-6	+0, -0,030
>6-10	+0, -0,036
>10-18	+0, -0,043
>18-30	+0, -0,052



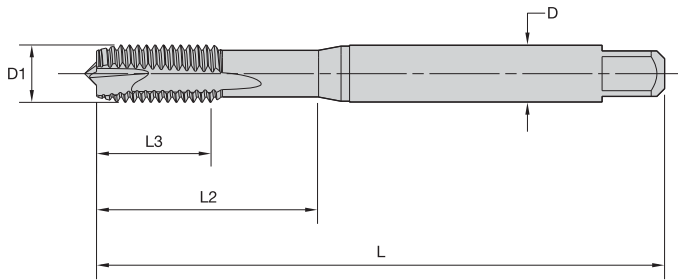
■ GT14 • Form B Plug Chamfer • Metric DIN 371 and 376 • For Titanium and Titanium Alloys



- first choice
- alternate choice

grade WN35MG TIN/DLC		metric dimensions					number of flutes	dimension standard	class of fit
order #	catalogue #	D1 size	L	L3	L2	D			
4160093	GT145001	M3 X 0,5	56	11	18	3,5	3	DIN 371	6HX
4160094	GT145002	M4 X 0,7	63	13	21	4,5	3	DIN 371	6HX
4160095	GT145003	M5 X 0,8	70	15	25	6,0	3	DIN 371	6HX
4160096	GT145004	M6 X 1	80	17	30	6,0	3	DIN 371	6HX
4160097	GT145005	M8 X 1,25	90	20	35	8,0	3	DIN 371	6HX
4160098	GT145006	M10 X 1,5	100	22	39	10,0	3	DIN 371	6HX
4160099	GT145007	M12 X 1,75	110	24	—	9,0	3	DIN 376	6HX

- WN48EG DLC for aluminium.

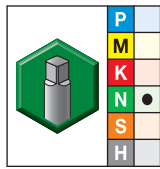


Shank Tolerance

D mm	tolerance h9
1-3	+0, -0,025
3,5-6	+0, -0,030
7-10	+0, -0,036
11-18	+0, -0,043



■ GT70 • Form B Plug Chamfer • Metric DIN 371 and 376 • For Aluminium



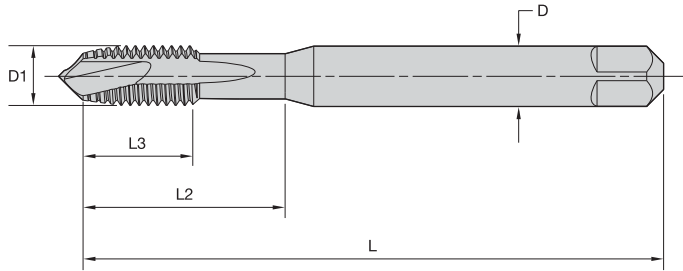
- first choice
- alternate choice

grade WN48EG DLC		metric dimensions					number of flutes	dimension standard	class of fit
order #	catalogue #	D1 size	L	L3	L2	D			
4160036	GT705001	M3 X 0,5	56	11	18	3,5	2	DIN 371	6H
4160037	GT705002	M4 X 0,7	63	13	21	4,5	2	DIN 371	6H
4160038	GT705003	M5 X 0,8	70	15	25	6,0	2	DIN 371	6H
4160039	GT705004	M6 X 1	80	17	30	6,0	2	DIN 371	6H
4160040	GT705005	M8 X 1,25	90	20	35	8,0	2	DIN 371	6H
4160041	GT705006	M10 X 1,5	100	22	39	10,0	2	DIN 371	6H
4160042	GT705007	M12 X 1,75	110	24	—	9,0	3	DIN 376	6H
4160063	GT705008	M16 X 2	110	27	—	12,0	3	DIN 376	6H

# High-Performance Taps

Victory™ Spiral-Point Plug HSS-E-PM Taps • Through Holes

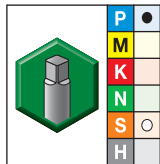
- WP31MG TiN for steel  
32–44 HRC.



Shank Tolerance	
D mm	tolerance h9
1–3	+0, -0,025
>3–6	+0, -0,030
>6–10	+0, -0,036
>10–18	+0, -0,043
>18–30	+0, -0,052



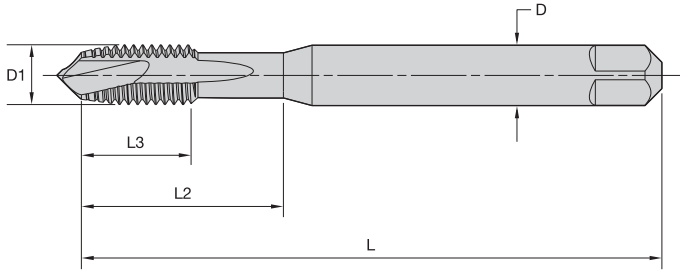
■ GT00 • Form B Plug Chamfer • Metric DIN 371, 374, and 376 • For Hard Steel



- first choice
- alternate choice

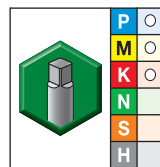
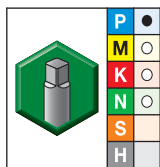
grade WP31MG TiN		metric dimensions					number of flutes	dimension standard	class of fit
order #	catalogue #	D1 size	L	L3	L2	D			
4153679	GT005001	M3 X 0,5	56	11	18	3,5	2	DIN 371	6HX
4153680	GT005002	M4 X 0,7	63	13	21	4,5	2	DIN 371	6HX
4153681	GT005003	M5 X 0,8	70	15	25	6,0	2	DIN 371	6HX
4153682	GT005004	M6 X 1	80	17	30	6,0	3	DIN 371	6HX
4153760	GT005012	M8 X 1	90	17	—	6,0	3	DIN 374	6HX
4153753	GT005005	M8 X 1,25	90	20	35	8,0	3	DIN 371	6HX
4153761	GT005013	M10 X 1	90	18	—	7,0	3	DIN 374	6HX
4153762	GT005014	M10 X 1,25	100	22	—	7,0	3	DIN 374	6HX
4153754	GT005006	M10 X 1,5	100	22	39	10,0	3	DIN 371	6HX
4153763	GT005015	M12 X 1,25	100	22	—	9,0	3	DIN 374	6HX
4153764	GT005016	M12 X 1,5	100	22	—	9,0	3	DIN 374	6HX
4153755	GT005007	M12 X 1,75	110	24	—	9,0	3	DIN 376	6HX
4153765	GT005017	M14 X 1,5	100	22	—	11,0	3	DIN 374	6HX
4153756	GT005008	M14 X 2	110	26	—	11,0	3	DIN 376	6HX
4153766	GT005018	M16 X 1,5	100	22	—	12,0	4	DIN 374	6HX
4153757	GT005009	M16 X 2	110	27	—	12,0	4	DIN 376	6HX
4153758	GT005010	M18 X 2	125	30	—	14,0	4	DIN 376	6HX
4153759	GT005011	M20 X 2,5	140	32	—	16,0	4	DIN 376	6HX

- WU41EG TiN
- WP49EG oxide



Shank Tolerance	
D mm	tolerance h9
1-3	+0, -0,025
>3-6	+0, -0,030
>6-10	+0, -0,036
>10-18	+0, -0,043
>18-30	+0, -0,052

■ VT-SPO • Form B Plug Chamfer • Machine Screw and Fractional • DIN 371 and 376



- first choice
- alternate choice

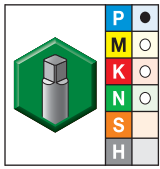
grade WU41EG TiN		grade WP49EG Oxide		metric dimensions					number of flutes	dimension standard	class of fit
order #	catalogue #	order #	catalogue #	D1 size	L	L3	L2	D			
5472633	VTSP06005	5387704	VTSP06005	4 - 40	56	8	18	3,5	2	DIN 371	2B
5472635	VTSP06007	5387707	VTSP06007	5 - 40	56	9	20	4,0	2	DIN 371	2B
5472636	VTSP06008	5387708	VTSP06008	6 - 32	56	9	20	4,0	2	DIN 371	2B
5472638	VTSP06010	5387760	VTSP06010	6 - 40	56	9	20	4,0	2	DIN 371	2B
5472639	VTSP06011	5387761	VTSP06011	8 - 32	63	11	21	4,5	2	DIN 371	2B
5472641	VTSP06013	5387763	VTSP06013	10 - 24	70	12	25	6,0	2	DIN 371	2B
5472644	VTSP06014	5387764	VTSP06014	10 - 32	70	12	25	6,0	2	DIN 371	2B
5472646	VTSP06016	5387766	VTSP06016	1/4 - 20	80	15	30	7,0	3	DIN 371	2B
5472647	VTSP06017	5387767	VTSP06017	1/4 - 28	80	15	30	7,0	3	DIN 371	2B
5472649	VTSP06019	5387769	VTSP06019	5/16 - 18	90	15	35	8,0	3	DIN 371	2B
5472650	VTSP06020	5387770	VTSP06020	5/16 - 24	90	15	35	8,0	3	DIN 371	2B
5472652	VTSP06022	5387772	VTSP06022	3/8 - 16	100	19	39	10,0	3	DIN 371	2B
5472653	VTSP06023	5387773	VTSP06023	3/8 - 24	100	19	39	10,0	3	DIN 371	2B
5472655	VTSP06025	5387776	VTSP06025	7/16 - 14	100	18	41	8,0	3	DIN 376	2B
5472656	VTSP06026	5387777	VTSP06026	7/16 - 20	100	18	41	8,0	3	DIN 376	2B
5472658	VTSP06028	5387779	VTSP06028	1/2 - 13	110	23	47	9,0	3	DIN 376	2B
5472659	VTSP06029	5387780	VTSP06029	1/2 - 20	110	23	47	9,0	3	DIN 376	2B
5472661	VTSP06031	5387782	VTSP06031	9/16 - 12	110	25	53	11,0	3	DIN 376	2B
5472662	VTSP06032	5387783	VTSP06032	9/16 - 18	110	25	53	11,0	3	DIN 376	2B
5472663	VTSP06033	5387784	VTSP06033	5/8 - 11	110	24	51	12,0	3	DIN 376	2B

(continued)

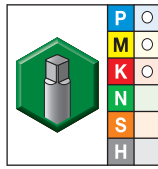
# Multipurpose Taps

VariTap™ Spiral-Point HSS-E Taps • Through Holes

(VT-SPO • Form B Plug Chamfer • Machine Screw and Fractional • DIN 371 and 376 — continued)



grade WU41EG  
TiN

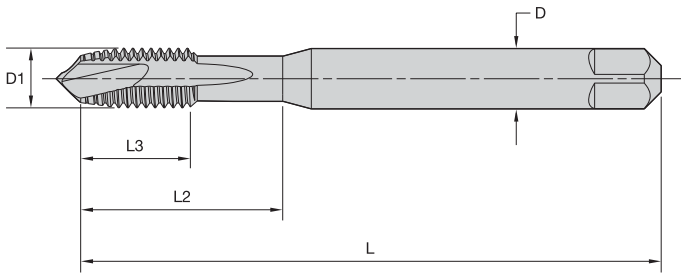


grade WP49EG  
Oxide

● first choice  
○ alternate choice

grade WU41EG TiN		grade WP49EG Oxide		metric dimensions					number of flutes	dimension standard	class of fit
order #	catalogue #	order #	catalogue #	D1 size	L	L3	L2	D			
5472664	VTSP06034	5387785	VTSP06034	5/8 - 18	110	24	51	12,0	3	DIN 376	2B
5472665	VTSP06035	5387786	VTSP06035	3/4 - 10	140	30	64	16,0	3	DIN 376	2B
5472666	VTSP06036	5387787	VTSP06036	3/4 - 16	140	30	64	16,0	3	DIN 376	2B
5472667	VTSP06037	5387788	VTSP06037	7/8 - 9	140	34	71	18,0	3	DIN 376	2B
5472668	VTSP06038	5387789	VTSP06038	7/8 - 14	140	34	71	18,0	3	DIN 376	2B
5472669	VTSP06039	5387790	VTSP06039	1 - 8	160	38	81	18,0	3	DIN 376	2B
5472670	VTSP06040	5387791	VTSP06040	1 - 12	160	38	81	18,0	3	DIN 376	2B

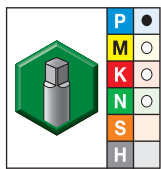
- WU41EG TiN
- WP49EG oxide



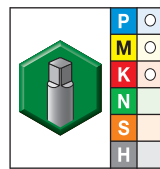
Shank Tolerance

D mm	tolerance h9
1-3	+0, -0,025
>3-6	+0, -0,030
>6-10	+0, -0,036
>10-18	+0, -0,043
>18-30	+0, -0,052

■ VT-SPO • Form B Plug Chamfer • UNJC/UNJF • Inch DIN 371 and 376



grade WU41EG  
TiN

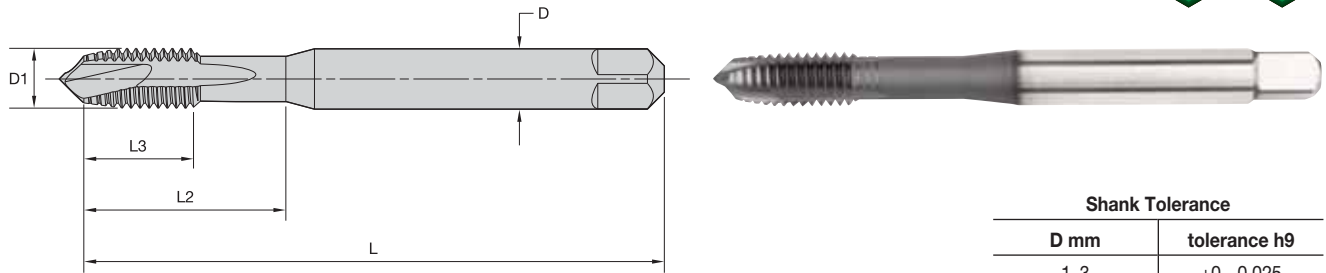


grade WP49EG  
Oxide

- first choice
- alternate choice

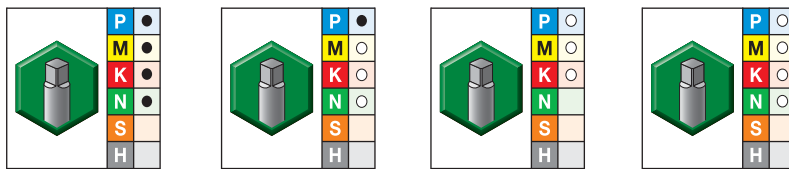
grade WU41EG TiN		grade WP49EG Oxide		metric dimensions					number of flutes	dimension standard	class of fit
order #	catalogue #	order #	catalogue #	D1 size	L	L3	L2	D			
5472634	VTSP06006	5387705	VTSP06006	4 - 40	56	8	18	3,5	2	DIN 371	3B
5472637	VTSP06009	5387709	VTSP06009	6 - 32	56	9	20	4,0	2	DIN 371	3B
5472640	VTSP06012	5387762	VTSP06012	8 - 32	63	11	21	4,5	2	DIN 371	3B
5472645	VTSP06015	5387765	VTSP06015	10 - 32	70	12	25	6,0	2	DIN 371	3B
5472648	VTSP06018	5387768	VTSP06018	1/4 - 28	80	15	30	7,0	3	DIN 371	3B
5472651	VTSP06021	5387771	VTSP06021	5/16 - 24	90	15	35	8,0	3	DIN 371	3B
5472654	VTSP06024	5387774	VTSP06024	3/8 - 24	100	19	39	10,0	3	DIN 371	3B
5472657	VTSP06027	5387778	VTSP06027	7/16 - 20	100	18	41	8,0	3	DIN 376	3B
5472660	VTSP06030	5387781	VTSP06030	1/2 - 20	110	23	47	9,0	3	DIN 376	3B

- WU40EG bright
- WU41EG TiN
- WP42EG TiCN
- WP49EG oxide



Shank Tolerance	
D mm	tolerance h9
1-3	+0, -0,025
>3-6	+0, -0,030
>6-10	+0, -0,036
>10-18	+0, -0,043
>18-30	+0, -0,052

■ VT-SPO • Form B Plug Chamfer • Metric DIN 371, 374, and 376



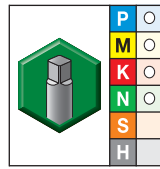
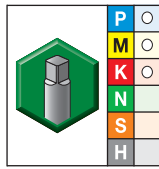
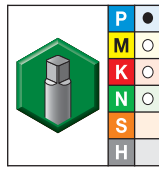
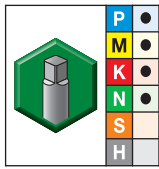
- first choice
- alternate choice

grade WP42EG TiCN		grade WU41EG TiN		grade WP49EG Oxide		grade WU40EG Bright		metric dimensions				number dimension class of flutes standard of fit			
order #	catalogue #	order #	catalogue #	order #	catalogue #	order #	catalogue #	D1 size	L	L3	L2	D			
5366647	VTSP06505	5366646	VTSP06505	5366648	VTSP06505	5366649	VTSP06505	M2 X 0,4	45	7	13	2,8	2	DIN 371	6H
-	-	-	-	5366660	VTSP06506	-	-	M2 X 0,4	45	7	13	2,8	2	DIN 371	6G
-	-	-	-	5366661	VTSP06507	-	-	M2,2 X 0,45	45	7	13	2,8	2	DIN 371	6H
-	-	5366662	VTSP06508	5366663	VTSP06508	5366664	VTSP06508	M2,5 X 0,45	50	7	15	2,8	2	DIN 371	6H
-	-	-	-	5366665	VTSP06509	-	-	M2,5 X 0,45	50	7	15	2,8	2	DIN 371	6G
-	-	-	-	5368602	VTSP06545	5368603	VTSP06545	M3 X 0,35	56	8	-	2,2	2	DIN 374	6H
-	-	5368514	VTSP06525	5368515	VTSP06525	5368516	VTSP06525	M3 X 0,5	56	8	-	2,2	2	DIN 376	6H
-	-	-	-	5366670	VTSP06511	-	-	M3 X 0,5	56	8	18	3,5	2	DIN 371	6G
5366667	VTSP06510	5366666	VTSP06510	5366668	VTSP06510	5366669	VTSP06510	M3 X 0,5	56	8	18	3,5	2	DIN 371	6H
-	-	5366671	VTSP06512	5366673	VTSP06512	5366674	VTSP06512	M3,5 X 0,6	56	9	20	4,0	2	DIN 371	6H
-	-	-	-	5368604	VTSP06546	5368605	VTSP06546	M4 X 0,5	63	10	21	2,8	2	DIN 374	6H
-	-	5368517	VTSP06526	5368518	VTSP06526	5368519	VTSP06526	M4 X 0,7	63	10	21	2,8	2	DIN 376	6H
-	-	-	-	5366679	VTSP06514	-	-	M4 X 0,7	63	11	21	4,5	2	DIN 371	6G
5366676	VTSP06513	5366675	VTSP06513	5366677	VTSP06513	5366678	VTSP06513	M4 X 0,7	63	11	21	4,5	2	DIN 371	6H
-	-	-	-	5368606	VTSP06547	5368607	VTSP06547	M5 X 0,5	70	12	25	3,5	2	DIN 374	6H
-	-	5368540	VTSP06527	5368541	VTSP06527	5368542	VTSP06527	M5 X 0,8	70	12	25	3,5	2	DIN 376	6H
-	-	-	-	5366685	VTSP06516	-	-	M5 X 0,8	70	12	25	6,0	2	DIN 371	6G
5366681	VTSP06515	5366680	VTSP06515	5366682	VTSP06515	5366684	VTSP06515	M5 X 0,8	70	12	25	6,0	2	DIN 371	6H
-	-	-	-	5368608	VTSP06548	5368609	VTSP06548	M6 X 0,5	80	12	30	4,5	3	DIN 374	6H
-	-	-	-	5368610	VTSP06549	5368611	VTSP06549	M6 X 0,75	80	12	30	4,5	3	DIN 374	6H
-	-	5368543	VTSP06528	5368544	VTSP06528	5368545	VTSP06528	M6 X 1	80	12	30	4,5	3	DIN 376	6H
5366687	VTSP06517	5366686	VTSP06517	5366688	VTSP06517	5366689	VTSP06517	M6 X 1	80	12	30	6,0	3	DIN 371	6H
-	-	-	-	5366690	VTSP06518	-	-	M6 X 1	80	12	30	6,0	3	DIN 371	6G
-	-	-	-	5368612	VTSP06550	5368613	VTSP06550	M7 X 0,75	80	12	30	5,5	3	DIN 374	6H

(continued)



(VT-SPO • Form B Plug Chamfer • Metric DIN 371, 374, and 376 – continued)



● first choice  
○ alternate choice

grade WP42EG TiCN		grade WU41EG TiN		grade WP49EG Oxide		grade WU40EG Bright		metric dimensions					number of flutes	dimension standard	class of fit
order #	catalogue #	order #	catalogue #	order #	catalogue #	order #	catalogue #	D1 size	L	L3	L2	D			
5366693	VTSP06519	5366692	VTSP06519	5366695	VTSP06519	5366696	VTSP06519	M7 X 1	80	12	30	7,0	3	DIN 371	6H
-	-	-	-	5366697	VTSP06520	-	-	M7 X 1	80	12	30	7,0	3	DIN 371	6G
-	-	-	-	5368614	VTSP06551	5368615	VTSP06551	M8 X 0,75	80	12	30	6,0	3	DIN 374	6H
-	-	-	-	5368616	VTSP06552	5368617	VTSP06552	M8 X 1	90	15	35	6,0	3	DIN 374	6H
-	-	5368546	VTSP06529	5368547	VTSP06529	5368548	VTSP06529	M8 X 1,25	90	15	35	6,0	3	DIN 376	6H
5366700	VTSP06521	5366698	VTSP06521	5366701	VTSP06521	5366703	VTSP06521	M8 X 1,25	90	15	35	8,0	3	DIN 371	6H
-	-	-	-	5366704	VTSP06522	-	-	M8 X 1,25	90	15	35	8,0	3	DIN 371	6G
-	-	-	-	5368618	VTSP06553	5368619	VTSP06553	M10 X 0,75	90	15	35	7,0	3	DIN 374	6H
-	-	-	-	5368620	VTSP06554	5368621	VTSP06554	M10 X 1	90	15	35	7,0	3	DIN 374	6H
-	-	-	-	5368622	VTSP06555	5368623	VTSP06555	M10 X 1,25	100	18	39	7,0	3	DIN 374	6H
-	-	-	-	5366709	VTSP06524	-	-	M10 X 1,5	100	18	39	10,0	3	DIN 371	6G
5366706	VTSP06523	5366705	VTSP06523	5366707	VTSP06523	5366708	VTSP06523	M10 X 1,5	100	18	39	10,0	3	DIN 371	6H
-	-	5368549	VTSP06530	5368550	VTSP06530	5368551	VTSP06530	M10 X 1,5	100	18	39	7,0	3	DIN 376	6H
-	-	-	-	5368624	VTSP06556	5368625	VTSP06556	M11 X 1	90	15	36	8,0	3	DIN 374	6H
-	-	-	-	5368626	VTSP06557	5368627	VTSP06557	M12 X 1	100	21	39	9,0	3	DIN 374	6H
-	-	-	-	5368628	VTSP06558	5368629	VTSP06558	M12 X 1,25	100	21	39	9,0	3	DIN 374	6H
-	-	-	-	5368630	VTSP06559	5368631	VTSP06559	M12 X 1,5	100	21	39	9,0	3	DIN 374	6H
-	-	-	-	5368556	VTSP06532	-	-	M12 X 1,75	110	21	44	9,0	3	DIN 376	6G
5368553	VTSP06531	5368552	VTSP06531	5368554	VTSP06531	5368555	VTSP06531	M12 X 1,75	110	21	44	9,0	3	DIN 376	6H
-	-	-	-	5368632	VTSP06560	5368633	VTSP06560	M14 X 1	100	21	47	11,0	3	DIN 374	6H
-	-	-	-	5368634	VTSP06561	5368635	VTSP06561	M14 X 1,25	100	21	47	11,0	3	DIN 374	6H
-	-	-	-	5368636	VTSP06562	5368637	VTSP06562	M14 X 1,5	100	21	47	11,0	3	DIN 374	6H
5368558	VTSP06533	5368557	VTSP06533	5368559	VTSP06533	5368560	VTSP06533	M14 X 2	110	24	52	11,0	3	DIN 376	6H
-	-	-	-	5368561	VTSP06534	-	-	M14 X 2	110	24	52	11,0	3	DIN 376	6G
-	-	-	-	5368638	VTSP06563	5368639	VTSP06563	M16 X 1	100	21	46	12,0	3	DIN 374	6H
-	-	-	-	5368640	VTSP06564	5368641	VTSP06564	M16 X 1,5	100	21	46	12,0	3	DIN 374	6H
5368563	VTSP06535	5368562	VTSP06535	5368565	VTSP06535	5368566	VTSP06535	M16 X 2	110	24	51	12,0	3	DIN 376	6H
-	-	-	-	5368567	VTSP06536	-	-	M16 X 2	110	24	51	12,0	3	DIN 376	6G
-	-	-	-	5368642	VTSP06565	5368643	VTSP06565	M18 X 1	110	21	50	14,0	3	DIN 374	6H
-	-	-	-	5368683	VTSP06566	5368684	VTSP06566	M18 X 1,5	110	21	50	14,0	3	DIN 374	6H
-	-	-	-	5368685	VTSP06567	5368686	VTSP06567	M18 X 2	125	30	58	14,0	3	DIN 374	6H
5368569	VTSP06537	5368568	VTSP06537	5368570	VTSP06537	5368571	VTSP06537	M18 X 2,5	125	30	58	14,0	3	DIN 376	6H
-	-	-	-	5368687	VTSP06568	5368688	VTSP06568	M20 X 1	125	24	56	16,0	3	DIN 374	6H
-	-	-	-	5368689	VTSP06569	5368690	VTSP06569	M20 X 1,5	125	24	56	16,0	3	DIN 374	6H
-	-	-	-	5368691	VTSP06570	5368692	VTSP06570	M20 X 2	140	30	64	16,0	3	DIN 374	6H
5368573	VTSP06538	5368572	VTSP06538	5368574	VTSP06538	5368575	VTSP06538	M20 X 2,5	140	30	64	16,0	3	DIN 376	6H

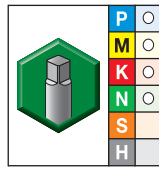
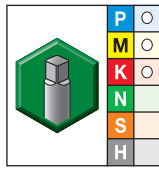
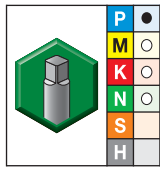
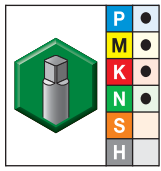
(continued)

Multipurpose Taps

# Multipurpose Taps

VariTap™ Spiral-Point HSS-E Taps • Through Holes

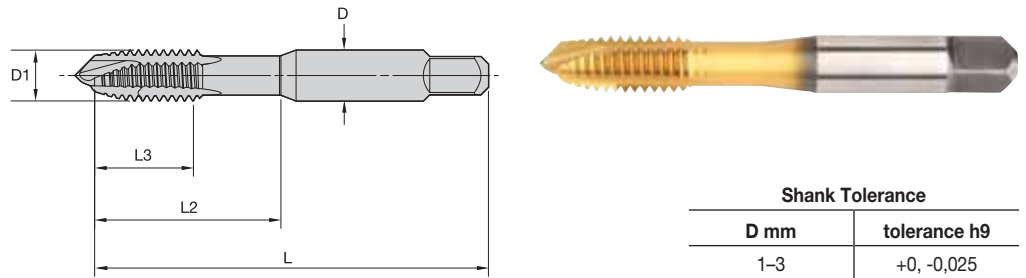
(VT-SPO • Form B Plug Chamfer • Metric DIN 371, 374, and 376 – continued)



● first choice  
○ alternate choice

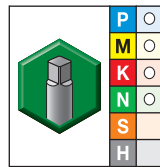
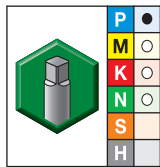
grade WP42EG TiCN		grade WU41EG TiN		grade WP49EG Oxide		grade WU40EG Bright		metric dimensions				number dimension class of flutes standard of fit			
order #	catalogue #	order #	catalogue #	order #	catalogue #	order #	catalogue #	D1 size	L	L3	L2	D			
-	-	-	-	5368693	VTSP06571	5368694	VTSP06571	M22 X 1,5	125	24	62	18,0	3	DIN 374	6H
-	-	-	-	-	-	5368695	VTSP06572	M22 X 2	140	30	70	18,0	3	DIN 374	6H
5368577	VTSP06539	5368576	VTSP06539	5368578	VTSP06539	5368579	VTSP06539	M22 X 2,5	140	30	70	18,0	3	DIN 376	6H
-	-	-	-	5368696	VTSP06573	5368697	VTSP06573	M24 X 1,5	140	28	67	18,0	3	DIN 374	6H
-	-	-	-	-	-	5368698	VTSP06574	M24 X 2	140	30	67	18,0	3	DIN 374	6H
5368581	VTSP06540	5368580	VTSP06540	5368582	VTSP06540	5368583	VTSP06540	M24 X 3	160	36	77	18,0	3	DIN 376	6H
-	-	5368584	VTSP06541	5368585	VTSP06541	5368586	VTSP06541	M27 X 3	160	36	82	20,0	4	DIN 376	6H
-	-	-	-	-	-	5368699	VTSP06575	M30 X 2	150	28	80	22,0	4	DIN 374	6H
-	-	5368587	VTSP06542	5368588	VTSP06542	5368589	VTSP06542	M30 X 3,5	180	42	91	22,0	4	DIN 376	6H
-	-	-	-	5368600	VTSP06543	-	-	M33 X 3,5	180	42	100	25,0	4	DIN 376	6H
-	-	-	-	5368601	VTSP06544	-	-	M36 X 4	200	48	110	28,0	4	DIN 376	6H

- WU40EG bright
- WU41EG TiN



Shank Tolerance	
D mm	tolerance h9
1-3	+0, -0,025
>3-6	+0, -0,030
>6-10	+0, -0,036
>10-18	+0, -0,043
>18-30	+0, -0,052

■ VT-SPO • Form B Plug Chamfer • Metric • JIS



- first choice
- alternate choice

grade WU41EG TiN		grade WU40EG Bright		metric dimensions					number of flutes	dimension standard	tap class
order #	catalogue #	order #	catalogue #	D1 size	L	L3	L2	D			
5387861	VTSP07505	5387859	VTSP07505	M3 X 0,5	46	11	19	4,0	2	JIS	ISO 2
5387865	VTSP07506	5387863	VTSP07506	M4 X 0,7	52	13	21	5,0	2	JIS	ISO 2
5387869	VTSP07507	5387867	VTSP07507	M5 X 0,8	60	16	24	5,5	2	JIS	ISO 2
5387873	VTSP07508	5387871	VTSP07508	M6 X 1	62	19	29	6,0	3	JIS	ISO 2
5387877	VTSP07509	5387875	VTSP07509	M8 X 1,25	70	22	37	6,2	3	JIS	ISO 2
5387881	VTSP07510	5387879	VTSP07510	M10 X 1,5	75	24	41	7,0	3	JIS	ISO 2
-		5387883	VTSP07511	M12 X 1,25	82	29	48	8,5	3	JIS	ISO 2
-		5387887	VTSP07513	M12 X 1,5	82	29	48	8,5	3	JIS	ISO 2
-		5387885	VTSP07512	M12 X 1,75	82	29	48	8,5	3	JIS	ISO 2
-		5387891	VTSP07515	M14 X 1,5	88	30	48	10,5	3	JIS	ISO 2
-		5387889	VTSP07514	M14 X 2	88	30	48	10,5	3	JIS	ISO 2
-		5387895	VTSP07517	M16 X 1,5	95	32	52	12,5	3	JIS	ISO 2
-		5387893	VTSP07516	M16 X 2	95	32	52	12,5	3	JIS	ISO 2
-		5387898	VTSP07518	M18 X 2,5	100	37	55	14,0	3	JIS	ISO 2
-		5387900	VTSP07519	M20 X 2,5	105	37	60	15,0	3	JIS	ISO 2

Solutions for Blind Hole Applications •

**WIDIA-GTD™**

# Spiral Flute



WIDIA-GTD™ offers a wide range of options for tapping blind holes in:

- Steel and steel alloys.
- Stainless steel.
- Cast iron.
- Wrought and cast aluminium.
- Nickel-based alloys.
- Titanium alloys.

## High-Performance Victory™ HSS-E-PM Taps

- Optimised spiral-flute designs enable deep blind holes to be threaded.
- Manufactured from powdered metal high-speed steel coated for thread cutting in various applications.
- Offer performance advantages over conventional high-speed steel taps.
- Long tap life at up to 50% higher tapping speed than HSS taps.
- PVD coatings offer outstanding thermal stability, hot hardness, oxidation resistance, and low coefficient of friction.
- Low runout of thread and chamfer.
- Excellent chip control.
- Reliable performance.
- Exceptional thread quality.

## Multipurpose VariTap™

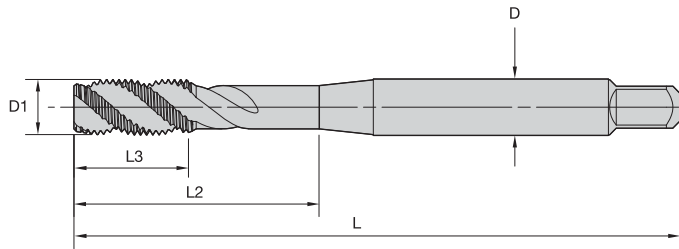
- Spiral-flute geometry optimised to provide efficient chip ejection in blind holes.
- Manufactured from high-vanadium HSS-E to provide long and consistent life.
- Ideal for customers who have a variety of materials to machine.
- Geometry designed to allow tapping of a wide variety of ductile materials: carbon and alloy steels, stainless steels, ductile iron, and cast aluminium.
- Wide range of inch and metric standard sizes, pitch diameter limits, classes of fit, chamfer styles, and coatings.



# High-Performance Taps

Victory™ Spiral-Flute HSS-E-PM Taps • Blind Holes

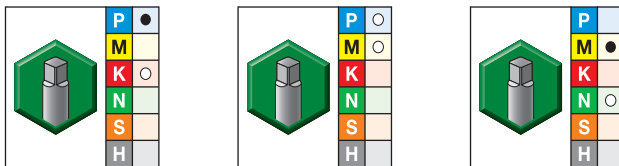
- GM6515 TiN + Cr/C for stainless steel.
- GP6520 TiCN for steel.
- GP6505 oxide for steel.



Shank Tolerance	
D mm	tolerance h6
>3-6	+0, -0,008
>6-10	+0, -0,009
>10-18	+0, -0,011
>18-30	+0, -0,013
>30-50	+0, -0,016



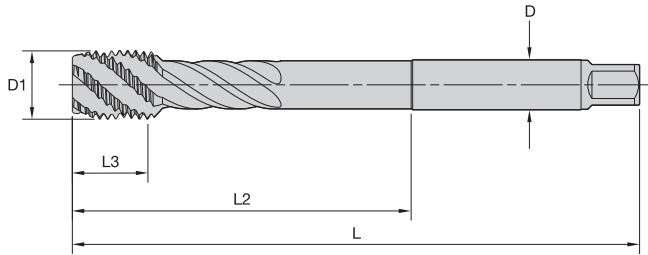
## ■ GT30 • Form C Semi-Bottoming Chamfer • Metric DIN 371, 374, and 376 • For Steel and Stainless Steel



- first choice
- alternate choice

grade GP6520 TiCN		grade GP6505 Oxide		grade GM6515 TiN+Cr/C/C		metric dimensions				number of flutes	dimension standard	class of fit	
order #	catalogue #	order #	catalogue #	order #	catalogue #	D1 size	L	L3	L2				D
3954929	GT305097	4035066	GT305116	3955098	GT305148	M3 X 0,5	56	8	18	3,5	3	DIN 371	6HX
3954930	GT305098	4035067	GT305117	3955099	GT305079	M4 X 0,7	63	10	21	4,5	3	DIN 371	6HX
3954931	GT305099	4035068	GT305118	3955100	GT305080	M5 X 0,8	70	10	25	6,0	3	DIN 371	6HX
3954932	GT305100	4035069	GT305119	3955101	GT305081	M6 X 1	80	10	30	6,0	3	DIN 371	6HX
3955031	GT305109	-	-	3955110	GT305090	M8 X 1	90	13	35	6,0	3	DIN 374	6HX
3955023	GT305101	4035070	GT305120	3955102	GT305082	M8 X 1,25	90	13	35	8,0	3	DIN 371	6HX
3955032	GT305110	-	-	3955111	GT305091	M10 X 1	90	10	35	7,0	3	DIN 374	6HX
3955033	GT305111	-	-	3955112	GT305092	M10 X 1,25	100	15	39	7,0	3	DIN 374	6HX
3955024	GT305102	4035071	GT305121	3955103	GT305083	M10 X 1,5	100	15	39	10,0	3	DIN 371	6HX
3955034	GT305112	-	-	3955113	GT305093	M12 X 1,5	100	15	39	9,0	4	DIN 374	6HX
3955025	GT305103	4035072	GT305122	3955104	GT305084	M12 X 1,75	110	18	44	9,0	4	DIN 376	6HX
3955035	GT305113	-	-	3955114	GT305094	M14 X 1,5	100	15	47	11,0	4	DIN 374	6HX
3955026	GT305104	4035073	GT305123	3955105	GT305085	M14 X 2	110	20	52	11,0	4	DIN 376	6HX
3955036	GT305114	-	-	3955115	GT305095	M16 X 1,5	100	15	46	12,0	4	DIN 374	6HX
3955027	GT305105	4035074	GT305124	3955106	GT305086	M16 X 2	110	20	51	12,0	4	DIN 376	6HX
3955037	GT305115	-	-	3955116	GT305096	M18 X 1,5	110	15	50	14,0	4	DIN 374	6HX
3955028	GT305106	-	-	3955107	GT305087	M18 X 2,5	125	25	58	14,0	4	DIN 376	6HX
3955029	GT305107	-	-	3955108	GT305088	M22 X 2,5	140	25	70	18,0	4	DIN 376	6HX
3955030	GT305108	-	-	3955109	GT305089	M24 X 3	160	30	77	18,0	5	DIN 376	6HX
4033733	GT305161	-	-	-	-	M24 X 3	160	30	77	18,0	5	DIN 376	6HX
4033735	GT305163	-	-	-	-	M30 X 3,5	180	35	91	22,0	5	DIN 376	6HX
4033736	GT305164	-	-	-	-	M33 X 3,5	180	35	100	25,0	5	DIN 376	6HX
4033738	GT305166	-	-	-	-	M36 X 4	200	40	110	28,0	5	DIN 376	6HX
4033740	GT305168	-	-	-	-	M42 X 4,5	200	45	120	32,0	5	DIN 376	6HX

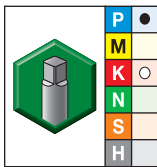
- GP6520 TiCN for steel and cast iron.



Shank Tolerance	
D mm	tolerance h6
12-18	+0, -0,011
20-30	+0, -0,013
32-36	+0, -0,016



- GT30 • Form C Semi-Bottoming Chamfer • Larger Sizes • Metric Extra Long • For Steel and Cast Iron



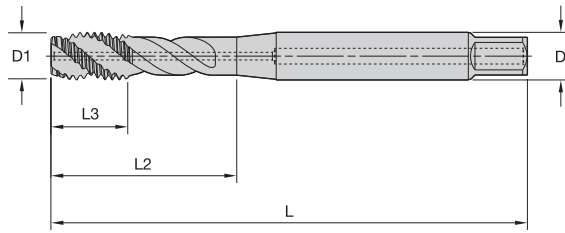
- first choice
- alternate choice

grade GP6520 TiCN		metric dimensions					number of flutes	class of fit
order #	catalogue #	D1 size	L	L3	L2	D		
4033776	GT305151	M24 X 3	200	30	120	18,0	5	6HX
4033778	GT305153	M30 X 3,5	250	35	150	22,0	5	6HX
4033779	GT305154	M33 X 3,5	250	35	150	25,0	5	6HX
4033781	GT305156	M36 X 4	250	40	150	28,0	5	6HX
4033783	GT305158	M42 X 4,5	300	45	180	32,0	5	6HX

# High-Performance Taps

Victory™ Spiral-Flute HSS-E-PM Taps • Blind Holes

- GM6515 TiN + CrC/C for stainless steel.
- GP6520 TiCN for steel.

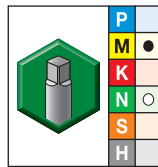
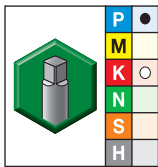


Shank Tolerance

D mm	tolerance h6
>3-6	+0, -0,008
>6-10	+0, -0,009
>10-18	+0, -0,011
>18-30	+0, -0,013
>30-50	+0, -0,016



■ GT31 • Form C Semi-Bottoming Chamfer • Through Coolant • Metric DIN 371 and 376 • For Steel and Stainless Steel

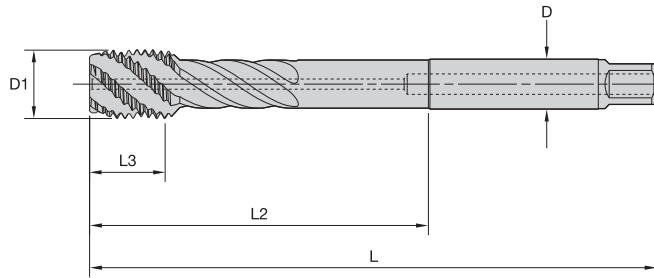


- first choice
- alternate choice

grade GP6520 TiCN		grade GM6515 TiN+CrC/C		metric dimensions					number of flutes	dimension standard	class of fit
order #	catalogue #	order #	catalogue #	D1 size	L	L3	L2	D			
3955349	GT315007	3955343	GT315001	M5 X 0,8	70	10	25	6,0	3	DIN 371	6HX
3955350	GT315008	3955344	GT315002	M6 X 1	80	10	30	6,0	3	DIN 371	6HX
3955351	GT315009	3955345	GT315003	M8 X 1,25	90	13	35	8,0	3	DIN 371	6HX
3955352	GT315010	3955346	GT315004	M10 X 1,5	100	15	39	10,0	3	DIN 371	6HX
3955373	GT315011	3955347	GT315005	M12 X 1,75	110	18	44	9,0	4	DIN 376	6HX
3955374	GT315012	3955348	GT315006	M14 X 2	110	20	52	11,0	4	DIN 376	6HX
5143530	GT315033	-	-	M16 X 2	110	20	51	12,0	4	DIN 376	6HX
5143531	GT315034	-	-	M18 X 2,5	125	25	58	14,0	4	DIN 376	6HX
5143532	GT315035	-	-	M20 X 2,5	140	25	64	16,0	4	DIN 376	6HX
4033744	GT315025	-	-	M24 X 3	160	30	77	18,0	5	DIN 376	6HX
4033746	GT315027	-	-	M30 X 3,5	180	35	91	22,0	5	DIN 376	6HX
4033747	GT315028	-	-	M33 X 3,5	180	35	100	25,0	5	DIN 376	6HX
4033749	GT315030	-	-	M36 X 4	200	40	110	28,0	5	DIN 376	6HX
4033751	GT315032	-	-	M42 X 4,5	200	45	120	32,0	5	DIN 376	6HX



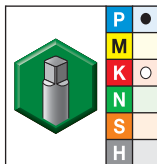
- GP6520 TiCN for steel and cast iron.



Shank Tolerance	
D mm	tolerance h6
12-18	+0, -0,011
20-30	+0, -0,013
32-36	+0, -0,016



- GT31 • Form C Semi-Bottoming Chamfer • Through Coolant • Larger Sizes • Metric Extra Long • For Steel and Cast Iron



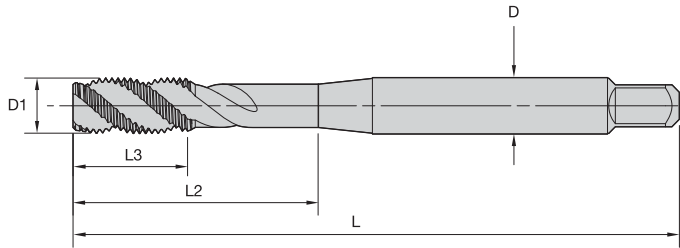
- first choice
- alternate choice

grade GP6520 TiCN		metric dimensions					number of flutes	class of fit
order #	catalogue #	D1 size	L	L3	L2	D		
4033787	GT315014	M24 X 3	200	30	120	18,0	5	6HX
4033789	GT315016	M30 X 3,5	250	35	150	22,0	5	6HX
4033790	GT315017	M33 X 3,5	250	35	150	25,0	5	6HX
4033792	GT315019	M36 X 4	250	40	150	28,0	5	6HX
4033794	GT315021	M42 X 4,5	300	45	180	32,0	5	6HX

# High-Performance Taps

Victory™ Spiral-Flute HSS-E-PM Taps • Threading Close to the Bottom in a Blind Hole

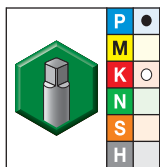
- GP6520 TiCN for steel.



Shank Tolerance	
D mm	tolerance h6
>3-6	+0, -0,008
>6-10	+0, -0,009
>10-18	+0, -0,011
>18-30	+0, -0,013
>30-50	+0, -0,016



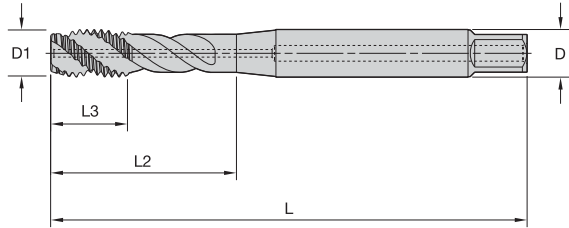
## GT32 • Form E Bottoming Chamfer • Metric DIN 371, 374, and 376 • For Steel



- first choice
- alternate choice

grade GP6520 TiCN		metric dimensions					number of flutes	dimension standard	class of fit
order #	catalogue #	D1 size	L	L3	L2	D			
4153906	GT325001	M5 X 0,8	70	10	25	6,0	3	DIN 371	6HX
4153907	GT325002	M6 X 1	80	10	30	6,0	3	DIN 371	6HX
4153908	GT325003	M8 X 1,25	90	13	35	8,0	3	DIN 371	6HX
4153909	GT325004	M10 X 1,5	100	15	39	10,0	3	DIN 371	6HX
4153912	GT325007	M12 X 1,5	100	15	39	9,0	4	DIN 374	6HX
4153910	GT325005	M12 X 1,75	110	18	44	9,0	4	DIN 376	6HX
4153953	GT325008	M14 X 1,5	100	15	47	11,0	4	DIN 374	6HX
4153911	GT325006	M14 X 2	110	20	52	11,0	4	DIN 376	6HX
4153954	GT325009	M16 X 1,5	100	15	46	12,0	4	DIN 374	6HX

- GP6520 TiCN for steel.

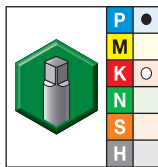


Shank Tolerance

D mm	tolerance h6
>3-6	+0, -0,008
>6-10	+0, -0,009
>10-18	+0, -0,011
>18-30	+0, -0,013
>30-50	+0, -0,016



- GT33 • Form E Bottoming Chamfer • Through Coolant • Metric DIN 371, 374, and 376 • For Steel



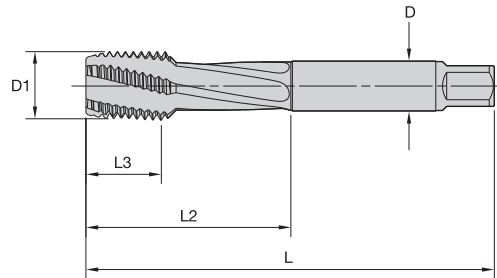
- first choice
- alternate choice

grade GP6520 TiCN		metric dimensions					number of flutes	dimension standard	class of fit
order #	catalogue #	D1 size	L	L3	L2	D			
4153955	GT335001	M5 X 0,8	70	10	25	6,0	3	DIN 371	6HX
4153956	GT335002	M6 X 1	80	10	30	6,0	3	DIN 371	6HX
4153957	GT335003	M8 X 1,25	90	13	35	8,0	3	DIN 371	6HX
4153958	GT335004	M10 X 1,5	100	15	39	10,0	3	DIN 371	6HX
4153961	GT335007	M12 X 1,5	100	15	39	9,0	4	DIN 374	6HX
4153959	GT335005	M12 X 1,75	110	18	44	9,0	4	DIN 376	6HX
4153962	GT335008	M14 X 1,5	100	15	47	11,0	4	DIN 374	6HX
4153960	GT335006	M14 X 2	110	20	52	11,0	4	DIN 376	6HX
4153963	GT335009	M16 X 1,5	100	15	46	12,0	4	DIN 374	6HX

# High-Performance Taps

Victory™ Spiral-Flute HSS-E-PM Taps • Blind Holes

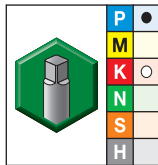
- GP6520 TiCN for steel and cast iron.



Shank Tolerance	
D mm	tolerance h6
12-18	+0, -0,011
20-30	+0, -0,013
32-36	+0, -0,016



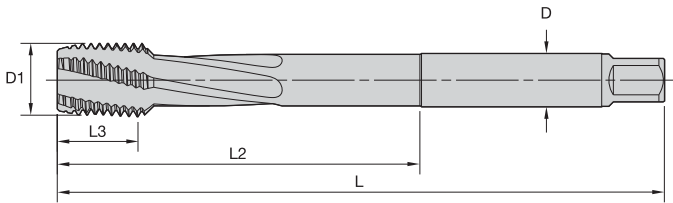
■ GT50 • Form C Semi-Bottoming Chamfer • Larger Sizes • Metric DIN 376 • For Steel and Cast Iron



- first choice
- alternate choice

grade GP6520 TiCN		metric dimensions					number of flutes	dimension standard	class of fit
order #	catalogue #	D1 size	L	L3	L2	D			
4154254	GT505001	M24 X 3	160	30	77	18,0	4	DIN 376	6HX
4154255	GT505002	M30 X 3,5	180	35	91	22,0	5	DIN 376	6HX
4154256	GT505003	M33 X 3,5	180	35	100	25,0	5	DIN 376	6HX
4154257	GT505004	M36 X 4	200	40	110	28,0	5	DIN 376	6HX
4154258	GT505005	M42 X 4,5	200	45	120	32,0	6	DIN 376	6HX

- GP6520 TiCN for steel and cast iron.

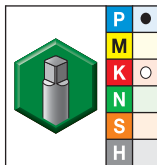


Shank Tolerance

D mm	tolerance h6
12-18	+0, -0,011
20-30	+0, -0,013
32-36	+0, -0,016



- GT50 • Form C Semi-Bottoming Chamfer • Larger Sizes • Metric Extra Long • For Steel and Cast Iron



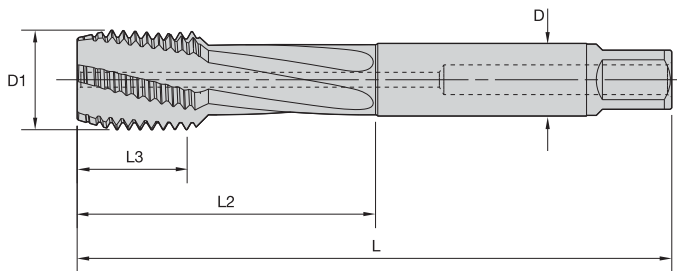
- first choice
- alternate choice

order #	catalogue #	grade GP6520 TiCN	metric dimensions				number of flutes	class of fit	
			D1 size	L	L3	L2			D
4154259	GT505006		M24 X 3	200	30	120	18,0	4	6HX
4154260	GT505007		M30 X 3,5	250	35	150	22,0	5	6HX
4154261	GT505008		M33 X 3,5	250	35	150	25,0	5	6HX
4154262	GT505009		M36 X 4	250	40	150	28,0	5	6HX
4154263	GT505010		M42 X 4,5	300	45	180	32,0	6	6HX

# High-Performance Taps

Victory™ Spiral-Flute HSS-E-PM Taps • Blind Holes

- GP6520 TiCN for steel and cast iron.

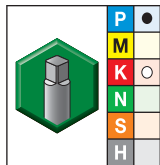


Shank Tolerance

D mm	tolerance h6
12-18	+0, -0,011
20-30	+0, -0,013
32-36	+0, -0,016



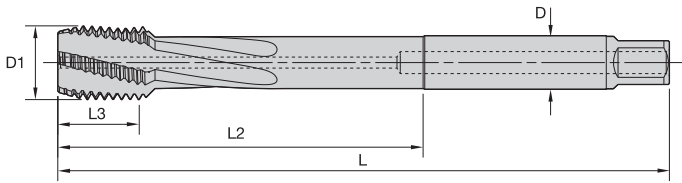
- GT51 • Form C Semi-Bottoming Chamfer • Through Coolant • Larger Sizes • Metric DIN 376 • For Steel and Cast Iron



- first choice
- alternate choice

grade GP6520 TiCN		metric dimensions					number of flutes	dimension standard	class of fit
order #	catalogue #	D1 size	L	L3	L2	D			
4154264	GT515001	M24 X 3	160	30	77	18,0	4	DIN 376	6HX
4154265	GT515002	M30 X 3,5	180	35	91	22,0	5	DIN 376	6HX
4154266	GT515003	M33 X 3,5	180	35	100	25,0	5	DIN 376	6HX
4154267	GT515004	M36 X 4	200	40	110	28,0	5	DIN 376	6HX
4154268	GT515005	M42 X 4,5	200	45	120	32,0	6	DIN 376	6HX

- GP6520 TiCN for tapping steel and cast iron.

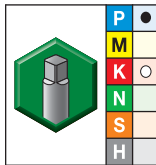


Shank Tolerance

D mm	tolerance h6
12-18	+0, -0,011
20-30	+0, -0,013
32-36	+0, -0,016



- GT51 • Form C Semi-Bottoming Chamfer • Through Coolant • Larger Sizes • Metric Extra Long • For Steel and Cast Iron



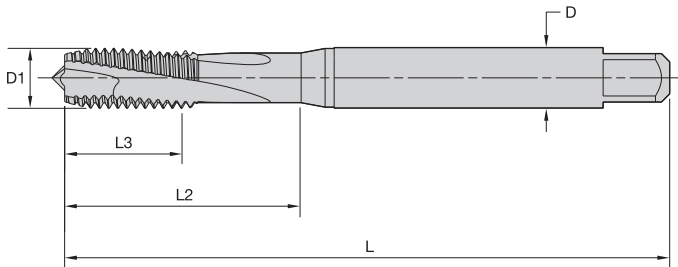
- first choice
- alternate choice

grade GP6520 TiCN		metric dimensions					number of flutes	class of fit
order #	catalogue #	D1 size	L	L3	L2	D		
4154269	GT515006	M24 X 3	200	30	120	18,0	4	6HX
4154270	GT515007	M30 X 3,5	250	35	150	22,0	5	6HX
4154271	GT515008	M33 X 3,5	250	35	150	25,0	5	6HX
4154272	GT515009	M36 X 4	250	40	150	28,0	5	6HX
4154273	GT515010	M42 X 4,5	300	45	180	32,0	6	6HX

# High-Performance Taps

Victory™ Spiral-Flute HSS-E-PM Taps • Blind Holes

- WS32MG TiCN for nickel and nickel alloys.

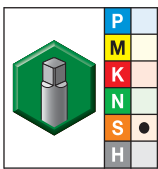


Shank Tolerance

D mm	tolerance h9
1-3	+0, -0,025
>3-6	+0, -0,030
>6-10	+0, -0,036
>10-18	+0, -0,043
>18-30	+0, -0,052



## ■ GT12 • Form C Semi-Bottoming Chamfer • Metric DIN 371 and 376 • For Nickel and Nickel Alloys

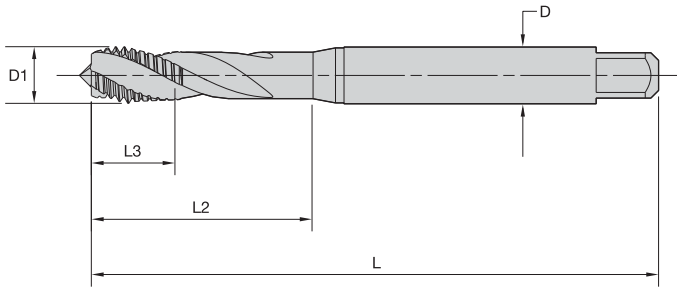


- first choice
- alternate choice

grade WS32MG TiCN		metric dimensions					number of flutes	dimension standard	class of fit
order #	catalogue #	D1 size	L	L3	L2	D			
4159636	GT125001	M3 X 0,5	56	11	18	3,5	2	DIN 371	6HX
4159637	GT125002	M4 X 0,7	63	13	21	4,5	3	DIN 371	6HX
4159638	GT125003	M5 X 0,8	70	15	25	6,0	3	DIN 371	6HX
4159639	GT125004	M6 X 1	80	17	30	6,0	3	DIN 371	6HX
4159640	GT125005	M8 X 1,25	90	20	35	8,0	3	DIN 371	6HX
4159641	GT125006	M10 X 1,5	100	22	39	10,0	3	DIN 371	6HX
4159642	GT125007	M12 X 1,75	110	24	—	9,0	3	DIN 376	6HX
4159663	GT125008	M14 X 2	110	26	—	11,0	3	DIN 376	6HX
4159664	GT125009	M16 X 2	110	27	—	12,0	3	DIN 376	6HX
4159665	GT125010	M20 X 2,5	140	32	—	16,0	3	DIN 376	6HX



- WN35MG TiN/DLC for titanium and titanium alloys.

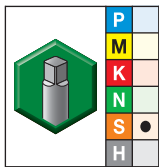


Shank Tolerance

D mm	tolerance h9
1-3	+0, -0,025
>3-6	+0, -0,030
>6-10	+0, -0,036
>10-18	+0, -0,043
>18-30	+0, -0,052



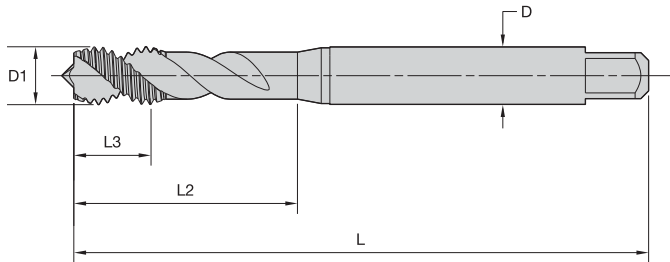
■ GT16 • Form C Semi-Bottoming Chamfer • Metric DIN 371 • For Titanium and Titanium Alloys



- first choice
- alternate choice

grade WN35MG TiN/DLC		metric dimensions					number of flutes	dimension standard	class of fit
order #	catalogue #	D1 size	L	L3	L2	D			
4160437	GT165001	M3 X 0,5	56	6	18	3,5	3	DIN 371	6HX
4160438	GT165002	M4 X 0,7	63	7	21	4,5	3	DIN 371	6HX
4160439	GT165003	M5 X 0,8	70	8	25	6,0	3	DIN 371	6HX
4160440	GT165004	M6 X 1	80	10	30	6,0	3	DIN 371	6HX
4160441	GT165005	M8 X 1,25	90	14	35	8,0	3	DIN 371	6HX
4160442	GT165006	M10 X 1,5	100	16	39	10,0	3	DIN 371	6HX
4160523	GT165007	M12 X 1,75	110	18	44	12,0	3	DIN 371	6HX

- WN48EG DLC for aluminium.

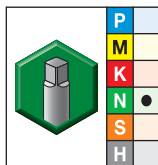


Shank Tolerance

D mm	tolerance h9
1-3	+0, -0,025
3,5-6	+0, -0,030
7-10	+0, -0,036
11-18	+0, -0,043



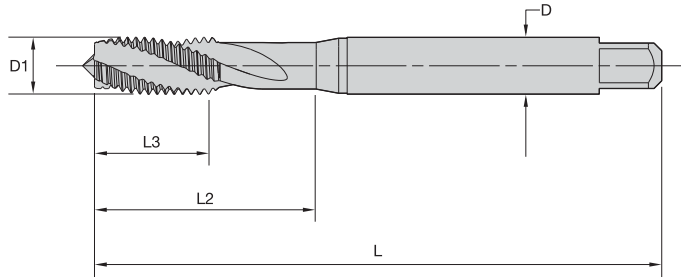
### ■ GT80 • Form C Semi-Bottoming Chamfer • Metric DIN 371 and 376 • For Aluminium



- first choice
- alternate choice

grade WN48EG DLC		metric dimensions					number of flutes	dimension standard	class of fit
order #	catalogue #	D1 size	L	L3	L2	D			
4160054	GT805001	M3 X 0,5	56	6	18	3,5	2	DIN 371	6H
4160055	GT805002	M4 X 0,7	63	7	21	4,5	2	DIN 371	6H
4160056	GT805003	M5 X 0,8	70	8	25	6,0	2	DIN 371	6H
4160057	GT805004	M6 X 1	80	10	30	6,0	2	DIN 371	6H
4160058	GT805005	M8 X 1,25	90	14	35	8,0	2	DIN 371	6H
4160059	GT805006	M10 X 1,5	100	16	39	10,0	2	DIN 371	6H
4160060	GT805007	M12 X 1,75	110	18	—	9,0	3	DIN 376	6H
4160061	GT805008	M16 X 2	110	22	—	12,0	3	DIN 376	6H
4160062	GT805009	M20 X 2,5	140	25	—	16,0	3	DIN 376	6H

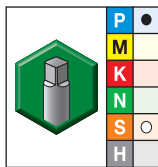
- WP31MG TiN  
for steel 32–44 HRC.



Shank Tolerance	
D mm	tolerance h9
1–3	+0, -0,025
>3–6	+0, -0,030
>6–10	+0, -0,036
>10–18	+0, -0,043
>18–30	+0, -0,052



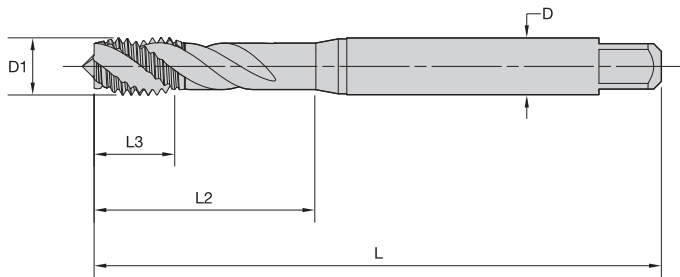
■ GT02 • Form C Semi-Bottoming Chamfer • Metric DIN 371, 374, and 376 • For Hard Steel



- first choice
- alternate choice

grade WP31MG TiN		metric dimensions					number of flutes	dimension standard	class of fit
order #	catalogue #	D1 size	L	L3	L2	D			
4152638	GT025001	M3 X 0,5	56	11	18	3,5	3	DIN 371	6H
4152639	GT025002	M4 X 0,7	63	13	21	4,5	3	DIN 371	6H
4152640	GT025003	M5 X 0,8	70	15	25	6,0	3	DIN 371	6H
4152641	GT025004	M6 X 1	80	17	30	6,0	3	DIN 371	6H
4152709	GT025012	M8 X 1	90	17	—	6,0	3	DIN 374	6H
4152642	GT025005	M8 X 1,25	90	20	35	8,0	3	DIN 371	6H
4152710	GT025013	M10 X 1	90	18	—	7,0	3	DIN 374	6H
4152711	GT025014	M10 X 1,25	100	22	—	7,0	3	DIN 374	6H
4152703	GT025006	M10 X 1,5	100	22	39	10,0	3	DIN 371	6H
4152712	GT025015	M12 X 1,25	100	22	—	9,0	3	DIN 374	6H
4152713	GT025016	M12 X 1,5	100	22	—	9,0	3	DIN 374	6H
4152704	GT025007	M12 X 1,75	110	24	44	12,0	3	DIN 376	6H
4152714	GT025017	M14 X 1,5	100	22	—	11,0	3	DIN 374	6H
4152705	GT025008	M14 X 2	110	26	52	11,0	3	DIN 376	6H
4152715	GT025018	M16 X 1,5	100	22	—	12,0	3	DIN 374	6H
4152706	GT025009	M16 X 2	110	27	—	12,0	3	DIN 376	6H
4152707	GT025010	M18 X 2	125	30	—	14,0	4	DIN 376	6H
4152708	GT025011	M20 X 2,5	140	32	—	16,0	4	DIN 376	6H

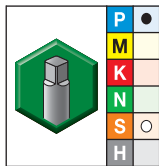
- WH36MG TiAlN/MoS<sub>2</sub> for steel  
32–44 HRC (3 x D).



Shank Tolerance	
D mm	tolerance h9
1–3	+0, -0,025
>3–6	+0, -0,030
>6–10	+0, -0,036
>10–18	+0, -0,043
>18–30	+0, -0,052



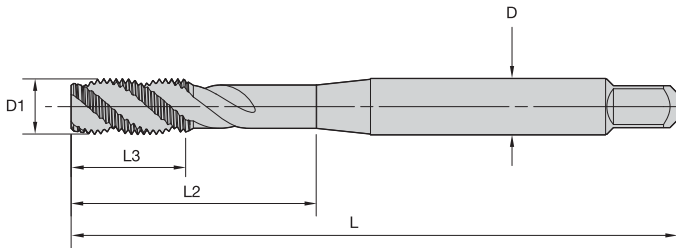
### ■ GT04 • Form C Semi-Bottoming Chamfer • Metric DIN 371, 374, and 376 • For Hard Steel



- first choice
- alternate choice

grade WH36MG TiN+MoS <sub>2</sub>		metric dimensions					number of flutes	dimension standard	class of fit
order #	catalogue #	D1 size	L	L3	L2	D			
4158471	GT045001	M3 X 0,5	56	6	18	3,5	3	DIN 371	6H
4158472	GT045002	M4 X 0,7	63	7	21	4,5	3	DIN 371	6H
4158763	GT045003	M5 X 0,8	70	8	25	6,0	3	DIN 371	6H
4158764	GT045004	M6 X 1	80	10	30	6,0	3	DIN 371	6H
4158772	GT045012	M8 X 1	90	10	—	6,0	3	DIN 374	6H
4158765	GT045005	M8 X 1,25	90	14	35	8,0	3	DIN 371	6H
4158773	GT045013	M10 X 1	90	10	—	7,0	3	DIN 374	6H
4158774	GT045014	M10 X 1,25	100	16	—	7,0	3	DIN 374	6H
4158766	GT045006	M10 X 1,5	100	16	39	10,0	3	DIN 371	6H
4158775	GT045015	M12 X 1,25	100	15	—	9,0	4	DIN 374	6H
4158776	GT045016	M12 X 1,5	100	15	—	9,0	4	DIN 374	6H
4158767	GT045007	M12 X 1,75	110	18	—	9,0	4	DIN 376	6H
4158777	GT045017	M14 X 1,5	100	15	—	11,0	4	DIN 374	6H
4158768	GT045008	M14 X 2	110	20	—	11,0	4	DIN 376	6H
4158778	GT045018	M16 X 1,5	100	15	—	12,0	4	DIN 374	6H
4158769	GT045009	M16 X 2	110	22	—	12,0	4	DIN 376	6H
4158770	GT045010	M18 X 2,5	125	25	—	14,0	4	DIN 376	6H
4158771	GT045011	M20 X 2,5	140	25	—	16,0	4	DIN 376	6H

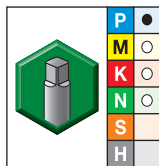
- WU41EG TiN.
- WP49EG oxide.



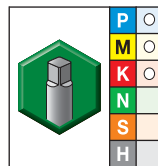
Shank Tolerance

D mm	tolerance h9
1-3	+0, -0,025
>3-6	+0, -0,030
>6-10	+0, -0,036
>10-18	+0, -0,043
>18-30	+0, -0,052

■ VT-SFT • Form C Semi-Bottoming Chamfer • Machine Screw and Fractional • DIN 371 and 376



grade WU41EG  
TiN



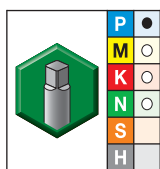
grade WP49EG  
Oxide

- first choice
- alternate choice

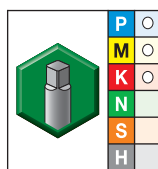
order #	catalogue #	order #	catalogue #	metric dimensions					number of flutes	dimension standard	class of fit
				D1 size	L	L3	L2	D			
5472587	VTSFT6005	5387487	VTSFT6005	4 - 40	56	8	18	3,5	2	DIN 371	2B
5472589	VTSFT6007	5387489	VTSFT6007	5 - 40	56	9	20	4,0	2	DIN 371	2B
5472600	VTSFT6008	5387640	VTSFT6008	6 - 32	56	9	20	4,0	2	DIN 371	2B
5472602	VTSFT6010	5387642	VTSFT6010	6 - 40	56	9	20	4,0	2	DIN 371	2B
5472603	VTSFT6011	5387643	VTSFT6011	8 - 32	63	11	21	4,5	3	DIN 371	2B
5472605	VTSFT6013	5387645	VTSFT6013	10 - 24	70	12	25	6,0	3	DIN 371	2B
5472606	VTSFT6014	5387646	VTSFT6014	10 - 32	70	12	25	6,0	3	DIN 371	2B
5472608	VTSFT6016	5387648	VTSFT6016	1/4 - 20	80	15	30	7,0	3	DIN 371	2B
5472609	VTSFT6017	5387649	VTSFT6017	1/4 - 28	80	15	30	7,0	3	DIN 371	2B
5472611	VTSFT6019	5387651	VTSFT6019	5/16 - 18	90	15	35	8,0	3	DIN 371	2B
5472612	VTSFT6020	5387652	VTSFT6020	5/16 - 24	90	15	35	8,0	3	DIN 371	2B
5472614	VTSFT6022	5387654	VTSFT6022	3/8 - 16	100	19	39	10,0	3	DIN 371	2B
5472615	VTSFT6023	5387655	VTSFT6023	3/8 - 24	100	19	39	10,0	3	DIN 371	2B
5472617	VTSFT6025	5387657	VTSFT6025	7/16 - 14	100	18	41	8,0	3	DIN 376	2B
5472618	VTSFT6026	5387658	VTSFT6026	7/16 - 20	100	18	41	8,0	3	DIN 376	2B
5472620	VTSFT6028	5387670	VTSFT6028	1/2 - 13	110	23	40	9,0	3	DIN 376	2B
5472621	VTSFT6029	5387671	VTSFT6029	1/2 - 20	110	23	40	9,0	3	DIN 376	2B
5472623	VTSFT6031	5387673	VTSFT6031	9/16 - 12	110	25	32	11,0	3	DIN 376	2B
5472624	VTSFT6032	5387674	VTSFT6032	9/16 - 18	110	25	32	11,0	3	DIN 376	2B
5472625	VTSFT6033	5387675	VTSFT6033	5/8 - 11	110	24	35	12,0	3	DIN 376	2B

(continued)

(VT-SFT • Form C Semi-Bottoming Chamfer • Machine Screw and Fractional • DIN 371 and 376 — continued)



grade WU41EG  
TiN



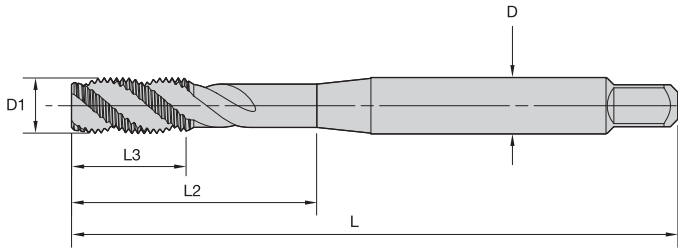
grade WP49EG  
Oxide

- first choice
- alternate choice

grade WU41EG TiN		grade WP49EG Oxide		metric dimensions					number of flutes	dimension standard	class of fit
order #	catalogue #	order #	catalogue #	D1 size	L	L3	L2	D			
5472626	VTSFT6034	5387676	VTSFT6034	5/8 - 18	110	24	35	12,0	3	DIN 376	2B
5472627	VTSFT6035	5387677	VTSFT6035	3/4 - 10	140	30	46	16,0	4	DIN 376	2B
5472628	VTSFT6036	5387678	VTSFT6036	3/4 - 16	140	30	46	16,0	4	DIN 376	2B
5472629	VTSFT6037	5387679	VTSFT6037	7/8 - 9	140	34	35	18,0	4	DIN 376	2B
5472630	VTSFT6038	5387700	VTSFT6038	7/8 - 14	140	34	35	18,0	4	DIN 376	2B
5472631	VTSFT6039	5387701	VTSFT6039	1 - 8	160	38	41	18,0	4	DIN 376	2B
5472632	VTSFT6040	5387702	VTSFT6040	1 - 12	160	38	41	18,0	4	DIN 376	2B

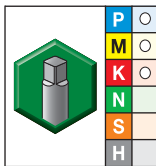


• WP49EG oxide



Shank Tolerance	
D mm	tolerance h9
1-3	+0, -0,025
>3-6	+0, -0,030
>6-10	+0, -0,036
>10-18	+0, -0,043
>18-30	+0, -0,052

■ VT-SFT • Form C Semi-Bottoming Chamfer • UNJC/UNJF • Inch DIN 371 and 376



- first choice
- alternate choice

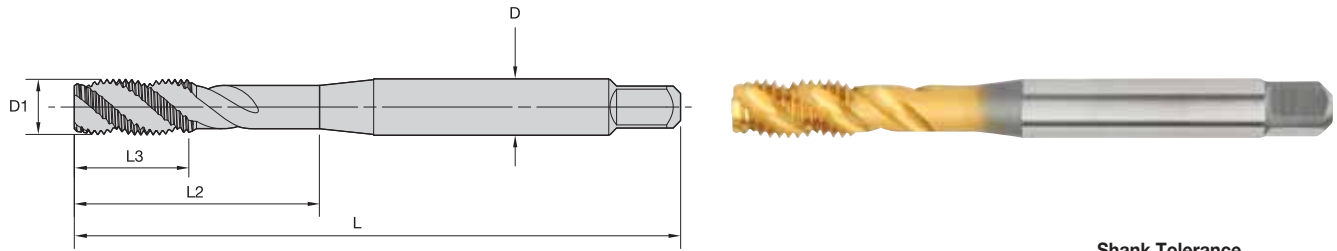
grade WP49EG Oxide		metric dimensions					number of flutes	dimension standard	class of fit
order #	catalogue #	D1 size	L	L3	L2	D			
5387488	VTSFT6006	4 - 40	56	8	18	3,5	2	DIN 371	3B
5387641	VTSFT6009	6 - 32	56	9	20	4,0	2	DIN 371	3B
5387644	VTSFT6012	8 - 32	63	11	21	4,5	3	DIN 371	3B
5387647	VTSFT6015	10 - 32	70	12	25	6,0	3	DIN 371	3B
5387650	VTSFT6018	1/4 - 28	80	15	30	7,0	3	DIN 371	3B
5387653	VTSFT6021	5/16 - 24	90	15	35	8,0	3	DIN 371	3B
5387656	VTSFT6024	3/8 - 24	100	19	39	10,0	3	DIN 371	3B
5387659	VTSFT6027	7/16 - 20	100	18	41	8,0	3	DIN 376	3B
5387672	VTSFT6030	1/2 - 20	110	23	40	9,0	3	DIN 376	3B

# Multipurpose Taps

VariTap™ Spiral-Flute HSS-E Taps • Blind Holes



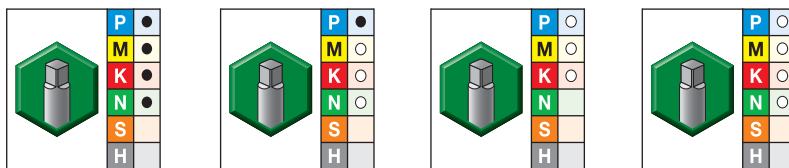
- WP42EG TiCN
- WU41EG TiN
- WP49EG oxide
- WU40EG bright



Shank Tolerance

D mm	tolerance h9
1-3	+0, -0,025
>3-6	+0, -0,030
>6-10	+0, -0,036
>10-18	+0, -0,043
>18-30	+0, -0,052

## ■ VT-SFT • Form C Semi-Bottoming Chamfer • Metric DIN 371, 374, and 376



- first choice
- alternate choice

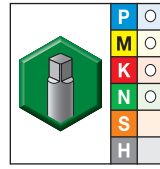
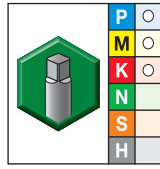
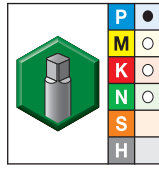
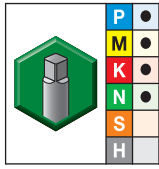
grade WP42EG TiCN		grade WU41EG TiN		grade WP49EG Oxide		grade WU40EG Bright		metric dimensions				number of flutes	dimension standard	class of fit	
order #	catalogue #	order #	catalogue #	order #	catalogue #	order #	catalogue #	D1 size	L	L3	L2				D
5368703	VTSFT6506	5368702	VTSFT6506	5368704	VTSFT6506	5368705	VTSFT6506	M2 X 0,4	45	7	13	2,8	2	DIN 371	6H
-	-	-	-	5368706	VTSFT6507	-	-	M2 X 0,4	45	7	13	2,8	2	DIN 371	6G
-	-	-	-	5368707	VTSFT6508	-	-	M2,2 X 0,45	45	7	13	2,8	2	DIN 371	6H
-	-	5368708	VTSFT6509	5368709	VTSFT6509	5368720	VTSFT6509	M2,5 X 0,45	50	7	15	2,8	2	DIN 371	6H
-	-	-	-	5368721	VTSFT6510	-	-	M2,5 X 0,45	50	7	15	2,8	2	DIN 371	6G
-	-	-	-	5402138	VTSFT6545	-	-	M3 X 0,35	56	8	-	2,2	2	DIN 374	6H
-	-	-	-	5368726	VTSFT6512	-	-	M3 X 0,5	56	8	18	3,5	2	DIN 371	6G
-	-	-	-	5402227	VTSFT6525	5402228	VTSFT6525	M3 X 0,5	56	8	-	2,2	2	DIN 376	6H
5368723	VTSFT6511	5368722	VTSFT6511	5368724	VTSFT6511	5368725	VTSFT6511	M3 X 0,5	56	8	18	3,5	2	DIN 371	6H
-	-	5368727	VTSFT6513	5368728	VTSFT6513	5368729	VTSFT6513	M3,5 X 0,6	56	9	20	4,0	2	DIN 371	6H
-	-	-	-	5402139	VTSFT6546	5402180	VTSFT6546	M4 X 0,5	63	10	21	2,8	3	DIN 374	6H
-	-	-	-	5368734	VTSFT6515	-	-	M4 X 0,7	63	11	21	4,5	3	DIN 371	6G
-	-	-	-	5402229	VTSFT6526	5402250	VTSFT6526	M4 X 0,7	63	10	21	2,8	3	DIN 376	6H
5368731	VTSFT6514	5368730	VTSFT6514	5368732	VTSFT6514	5368733	VTSFT6514	M4 X 0,7	63	11	21	4,5	3	DIN 371	6H
-	-	-	-	5402181	VTSFT6547	5402182	VTSFT6547	M5 X 0,5	70	12	25	3,5	3	DIN 374	6H
-	-	-	-	5368739	VTSFT6517	-	-	M5 X 0,8	70	12	25	6,0	3	DIN 371	6G
-	-	-	-	5402251	VTSFT6527	5402252	VTSFT6527	M5 X 0,8	70	12	25	3,5	3	DIN 376	6H
5368736	VTSFT6516	5368735	VTSFT6516	5368737	VTSFT6516	5368738	VTSFT6516	M5 X 0,8	70	12	25	6,0	3	DIN 371	6H
-	-	-	-	5402183	VTSFT6548	-	-	M6 X 0,5	80	12	30	4,5	3	DIN 374	6H
-	-	-	-	5402185	VTSFT6549	5402184	VTSFT6549	M6 X 0,75	80	12	30	4,5	3	DIN 374	6H

(continued)

Multipurpose Taps



(VT-SFT • Form C Semi-Bottoming Chamfer • Metric DIN 371, 374, and 376 – continued)

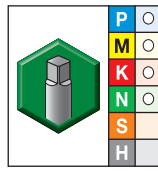
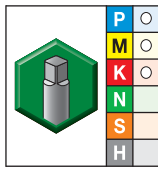
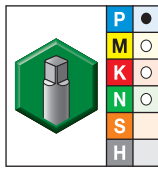
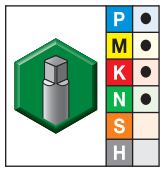


● first choice  
○ alternate choice

grade WP42EG TiCN		grade WU41EG TiN		grade WP49EG Oxide		grade WU40EG Bright		metric dimensions					number of flutes	dimension standard	class of fit
order #	catalogue #	order #	catalogue #	order #	catalogue #	order #	catalogue #	D1 size	L	L3	L2	D			
5368741	VTSFT6518	5368740	VTSFT6518	5368742	VTSFT6518	5368743	VTSFT6518	M6 X 1	80	12	30	6,0	3	DIN 371	6H
-	-	-	-	5402253	VTSFT6528	5402254	VTSFT6528	M6 X 1	80	12	30	4,5	3	DIN 376	6H
-	-	-	-	5368744	VTSFT6519	-	-	M6 X 1	80	12	30	6,0	3	DIN 371	6G
-	-	-	-	5368745	VTSFT6520	5368746	VTSFT6520	M7 X 1	80	12	30	7,0	3	DIN 371	6H
-	-	-	-	5402186	VTSFT6550	5402187	VTSFT6550	M8 X 0,75	80	12	30	6,0	3	DIN 374	6H
5402188	VTSFT6551	-	-	5402189	VTSFT6551	5402190	VTSFT6551	M8 X 1	90	15	35	6,0	3	DIN 374	6H
-	-	-	-	5368752	VTSFT6522	-	-	M8 X 1,25	90	15	35	8,0	3	DIN 371	6G
-	-	-	-	5402255	VTSFT6529	5402256	VTSFT6529	M8 X 1,25	90	15	35	6,0	3	DIN 376	6H
5368749	VTSFT6521	5368748	VTSFT6521	5368750	VTSFT6521	5368751	VTSFT6521	M8 X 1,25	90	15	35	8,0	3	DIN 371	6H
-	-	-	-	-	-	5402191	VTSFT6552	M10 X 0,75	90	15	35	7,0	3	DIN 374	6H
-	-	-	-	5402192	VTSFT6553	5402193	VTSFT6553	M10 X 1	90	15	35	7,0	3	DIN 374	6H
5402194	VTSFT6554	-	-	5402195	VTSFT6554	5402196	VTSFT6554	M10 X 1,25	100	18	39	7,0	3	DIN 374	6H
5368754	VTSFT6523	5368753	VTSFT6523	5368755	VTSFT6523	5368756	VTSFT6523	M10 X 1,5	100	18	39	10,0	3	DIN 371	6H
-	-	-	-	5368757	VTSFT6524	-	-	M10 X 1,5	100	18	39	10,0	3	DIN 371	6G
-	-	-	-	5402257	VTSFT6530	5402258	VTSFT6530	M10 X 1,5	100	18	39	7,0	3	DIN 376	6H
-	-	-	-	5402197	VTSFT6555	5402198	VTSFT6555	M12 X 1	100	21	39	9,0	3	DIN 374	6H
-	-	-	-	5402199	VTSFT6556	5402200	VTSFT6556	M12 X 1,25	100	21	39	9,0	3	DIN 374	6H
5402201	VTSFT6557	-	-	5402202	VTSFT6557	5402203	VTSFT6557	M12 X 1,5	100	21	39	9,0	3	DIN 374	6H
-	-	-	-	5402263	VTSFT6532	-	-	M12 X 1,75	110	21	44	9,0	3	DIN 376	6G
5402260	VTSFT6531	5402259	VTSFT6531	5402261	VTSFT6531	5402262	VTSFT6531	M12 X 1,75	110	21	44	9,0	3	DIN 376	6H
-	-	-	-	-	-	5402204	VTSFT6558	M14 X 1	100	21	47	11,0	3	DIN 374	6H
-	-	-	-	-	-	5402205	VTSFT6559	M14 X 1,25	100	21	47	11,0	3	DIN 374	6H
5402206	VTSFT6560	-	-	5402207	VTSFT6560	5402208	VTSFT6560	M14 X 1,5	100	21	47	11,0	3	DIN 374	6H
-	-	-	-	5402268	VTSFT6534	-	-	M14 X 2	110	24	52	11,0	3	DIN 376	6G
5402265	VTSFT6533	5402264	VTSFT6533	5402266	VTSFT6533	5402267	VTSFT6533	M14 X 2	110	24	52	11,0	3	DIN 376	6H
-	-	-	-	-	-	5402209	VTSFT6561	M16 X 1	100	21	46	12,0	3	DIN 374	6H
-	-	-	-	5402210	VTSFT6562	5402211	VTSFT6562	M16 X 1,5	100	21	46	12,0	3	DIN 374	6H
-	-	-	-	5402272	VTSFT6536	-	-	M16 X 2	110	24	51	12,0	3	DIN 376	6G
-	-	5402269	VTSFT6535	5402270	VTSFT6535	5402271	VTSFT6535	M16 X 2	110	24	51	12,0	3	DIN 376	6H
-	-	-	-	-	-	5402212	VTSFT6563	M18 X 1	110	21	50	14,0	4	DIN 374	6H
-	-	-	-	5402214	VTSFT6564	5402213	VTSFT6564	M18 X 1,5	110	21	50	14,0	4	DIN 374	6H
-	-	-	-	-	-	5402215	VTSFT6565	M18 X 2	125	30	58	14,0	4	DIN 374	6H
-	-	5402273	VTSFT6537	5402274	VTSFT6537	5402275	VTSFT6537	M18 X 2,5	125	30	58	14,0	4	DIN 376	6H
-	-	-	-	-	-	5402216	VTSFT6566	M20 X 1	125	24	56	16,0	4	DIN 374	6H
-	-	-	-	5402217	VTSFT6567	5402218	VTSFT6567	M20 X 1,5	125	24	56	16,0	4	DIN 374	6H
-	-	-	-	-	-	5402219	VTSFT6568	M20 X 2	140	30	64	16,0	4	DIN 374	6H
-	-	5402276	VTSFT6538	5402277	VTSFT6538	5402278	VTSFT6538	M20 X 2,5	140	30	64	16,0	4	DIN 376	6H
-	-	-	-	5402220	VTSFT6569	5402221	VTSFT6569	M22 X 1,5	125	24	62	18,0	4	DIN 374	6H
-	-	-	-	-	-	5402222	VTSFT6570	M22 X 2	140	30	70	18,0	4	DIN 374	6H
-	-	5402279	VTSFT6539	5402280	VTSFT6539	5402281	VTSFT6539	M22 X 2,5	140	30	70	18,0	4	DIN 376	6H

(continued)

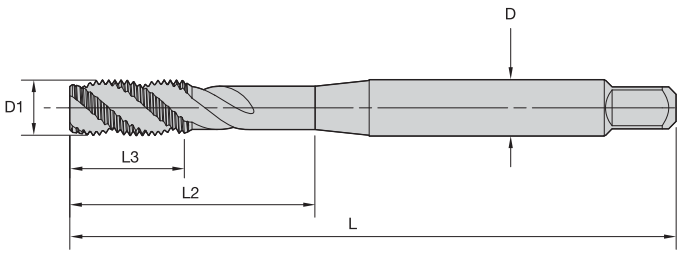
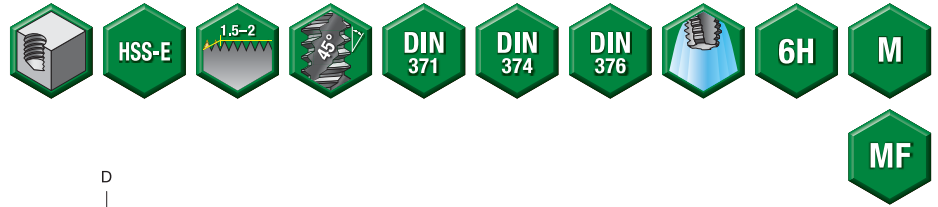
(VT-SFT • Form C Semi-Bottoming Chamfer • Metric DIN 371, 374, and 376 — continued)



● first choice  
○ alternate choice

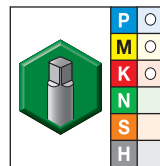
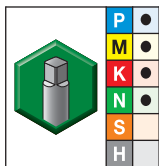
grade WP42EG TiCN		grade WU41EG TiN		grade WP49EG Oxide		grade WU40EG Bright		metric dimensions				number of flutes	dimension standard	class of fit	
order #	catalogue #	order #	catalogue #	order #	catalogue #	order #	catalogue #	D1 size	L	L3	L2	D			
-	-	-	-	5402223	VTSFT6571	5402224	VTSFT6571	M24 X 1,5	140	28	67	18,0	4	DIN 374	6H
-	-	-	-	-	-	5402225	VTSFT6572	M24 X 2	140	28	67	18,0	4	DIN 374	6H
-	5402282	VTSFT6540	5402283	VTSFT6540	5402284	VTSFT6540	M24 X 3	160	36	77	18,0	4	DIN 376	6H	
-	5402285	VTSFT6541	5402286	VTSFT6541	5402287	VTSFT6541	M27 X 3	160	36	82	20,0	4	DIN 376	6H	
-	-	-	-	-	5402226	VTSFT6573	M30 X 2	150	28	80	22,0	2	DIN 374	6H	
-	5402288	VTSFT6542	5402289	VTSFT6542	5402290	VTSFT6542	M30 X 3,5	180	42	91	22,0	4	DIN 376	6H	
-	-	-	5402291	VTSFT6543	5402292	VTSFT6543	M33 X 3,5	180	42	100	25,0	4	DIN 376	6H	
-	-	-	5402293	VTSFT6544	5402294	VTSFT6544	M36 X 4	200	48	110	28,0	5	DIN 376	6H	

- WP42EG TiCN
- WP49EG oxide



Shank Tolerance	
D mm	tolerance h9
1-3	+0, -0,025
>3-6	+0, -0,030
>6-10	+0, -0,036
>10-18	+0, -0,043
>18-30	+0, -0,052

■ VT-SFT • Form E Bottoming Chamfer • Metric DIN 371, 374, and 376



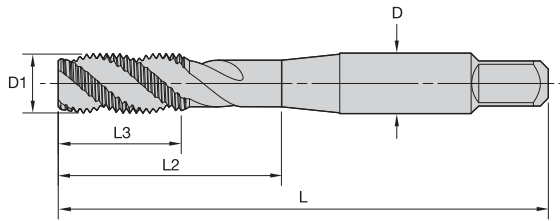
- first choice
- alternate choice

grade WP42EG TiCN		grade WP49EG Oxide		metric dimensions					number of flutes	dimension standard	class of fit
order #	catalogue #	order #	catalogue #	D1 size	L	L3	L2	D			
5387434	VTSFT6574	5387435	VTSFT6574	M3 X 0,5	56	8	18	3,5	2	DIN 371	6H
5387436	VTSFT6575	5387437	VTSFT6575	M4 X 0,7	63	11	21	4,5	3	DIN 371	6H
5387438	VTSFT6576	5387439	VTSFT6576	M5 X 0,8	70	12	25	6,0	3	DIN 371	6H
5387460	VTSFT6577	5387461	VTSFT6577	M6 X 1	80	12	30	6,0	3	DIN 371	6H
5387475	VTSFT6585	5387476	VTSFT6585	M8 X 1	90	15	35	6,0	3	DIN 374	6H
5387462	VTSFT6578	5387463	VTSFT6578	M8 X 1,25	90	15	35	8,0	3	DIN 371	6H
5387477	VTSFT6586	5387478	VTSFT6586	M10 X 1,25	100	18	39	7,0	3	DIN 374	6H
5387464	VTSFT6579	5387465	VTSFT6579	M10 X 1,5	100	18	39	10,0	3	DIN 371	6H
5387479	VTSFT6587	5387481	VTSFT6587	M12 X 1,5	100	21	39	9,0	3	DIN 374	6H
5387466	VTSFT6580	5387467	VTSFT6580	M12 X 1,75	110	21	44	9,0	3	DIN 376	6H
5387482	VTSFT6588	5387483	VTSFT6588	M14 X 1,5	100	21	47	11,0	3	DIN 374	6H
5387468	VTSFT6581	5387469	VTSFT6581	M14 X 2	110	24	52	11,0	3	DIN 376	6H
-		5387470	VTSFT6582	M16 X 2	110	24	51	12,0	3	DIN 376	6H
5387471	VTSFT6583	5387472	VTSFT6583	M18 X 2,5	125	30	58	14,0	4	DIN 376	6H
5387473	VTSFT6584	5387474	VTSFT6584	M20 X 2,5	140	30	64	16,0	4	DIN 376	6H

# Multipurpose Taps

VariTap™ Spiral-Flute HSS-E Taps • Blind Holes

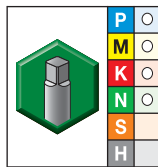
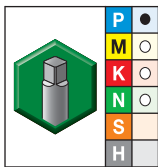
- WU41EG TiN
- WU40EG bright



Shank Tolerance

D mm	tolerance h9
1-3	+0, -0,025
>3-6	+0, -0,030
>6-10	+0, -0,036
>10-18	+0, -0,043
>18-30	+0, -0,052

## ■ VT-SFT • Form C Semi-Bottoming Chamfer • Metric • JIS



- first choice
- alternate choice

grade WU41EG TiN		grade WU40EG Bright		metric dimensions					number of flutes	dimension standard	tap class
order #	catalogue #	order #	catalogue #	D1 size	L	L3	L2	D			
5398709	VTSFT7505	5398708	VTSFT7505	M3 X 0,5	46	11	19	4,0	2	JIS	ISO 2
5398791	VTSFT7506	5398790	VTSFT7506	M4 X 0,7	52	13	21	5,0	3	JIS	ISO 2
5398793	VTSFT7507	5398792	VTSFT7507	M5 X 0,8	60	16	24	5,5	3	JIS	ISO 2
5398795	VTSFT7508	5398794	VTSFT7508	M6 X 1	62	19	29	6,0	3	JIS	ISO 2
5398797	VTSFT7509	5398796	VTSFT7509	M8 X 1,25	70	22	37	6,2	3	JIS	ISO 2
5398799	VTSFT7510	5398798	VTSFT7510	M10 X 1,5	75	24	41	7,0	3	JIS	ISO 2
-		5398800	VTSFT7511	M12 X 1,25	82	29	48	8,5	3	JIS	ISO 2
-		5398802	VTSFT7513	M12 X 1,5	82	29	48	8,5	3	JIS	ISO 2
-		5398801	VTSFT7512	M12 X 1,75	82	29	48	8,5	3	JIS	ISO 2
-		5398804	VTSFT7515	M14 X 1,5	88	30	48	10,5	3	JIS	ISO 2
-		5398803	VTSFT7514	M14 X 2	88	30	48	10,5	3	JIS	ISO 2
-		5398806	VTSFT7517	M16 X 1,5	95	32	52	12,5	3	JIS	ISO 2
-		5398805	VTSFT7516	M16 X 2	95	32	52	12,5	3	JIS	ISO 2
-		5398807	VTSFT7518	M18 X 2,5	100	37	55	14,0	4	JIS	ISO 2
-		5398808	VTSFT7519	M20 X 2,5	105	37	60	15,0	4	JIS	ISO 2

# Tap into the power of the original.



## WIDIA™ VariTap™

**A heritage of hard work, innovation, and excellence. That's what makes an original.**

Built on a 140-year legacy of providing the industry with the highest quality performance in taps, dies, and gages. Our history propels us to keep delivering the most advanced solutions.

The WIDIA VariTap is the next application of our commitment to innovation.

- Extensive range of sizes, fits, styles, and coatings, equipped with optimised geometry, offering the largest portfolio solution of multipurpose taps available.
- Capable of working with a wide variety of materials.
- Long and consistent tool life leading to lower inventory costs.
- Unique spiral-point geometry provides low tapping torque, while pushing chips ahead of the tap in through holes.
- Superior thread finish.

To learn more about the unmatched benefits of WIDIA VariTap, call 800.979.4342, contact your local Authorised Distributor, or visit [widia.com/varitap](http://widia.com/varitap).

**WIDIA** 

Solutions for Through and Blind Hole Applications •

**WIDIA-GTD™**

# Straight Flute



WIDIA-GTD™ offers a wide range of straight-flute options for tapping through and blind holes in:

- Cast iron.
- Aluminium.

## High-Performance Victory™ Solid Carbide Taps

- Straight flute designed for outstanding tool life in cast iron, aluminium, and hardened materials.
- Manufactured with fine-grain micrograin carbide for exceptional wear life.
- Ideal for long production runs where fewer tool changes mean greater productivity.
- Runs up to 4x faster and lasts up to 4x longer than conventional high-speed steel taps.
- Excellent thread quality and tap performance.

## High-Performance Victory™ HSS-E-PM Taps

- Straight-flute taps store chips in hole or are flushed out with internal coolant.
- Manufactured from powdered metal high-speed steel coated for thread cutting in cast iron and aluminium.
- Offer performance advantages over conventional high-speed steel taps.
- Long tap life at up to 50% higher tapping speed than HSS taps.

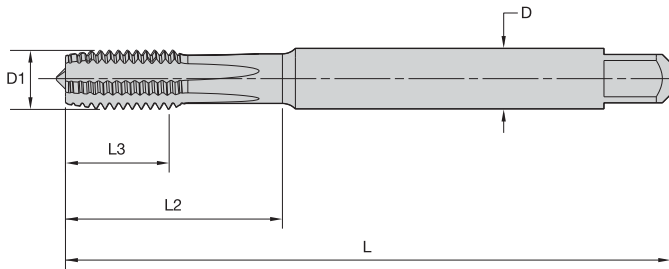


# High-Performance Taps

Victory™ Straight-Flute Carbide Taps • Blind and Through Holes



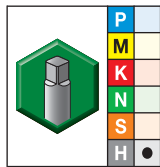
- WH16PG TiAlN/MoS<sub>2</sub> for steel 55–63 HRC.



Shank Tolerance	
D mm	tolerance h6
1–3	+0, -0,025
3,5–6	+0, -0,030
7–10	+0, -0,036
11–18	+0, -0,043



■ GX10 • Form C Semi-Bottoming Chamfer • Metric DIN 371, 374, and 376 • For Hard Steel



- first choice
- alternate choice

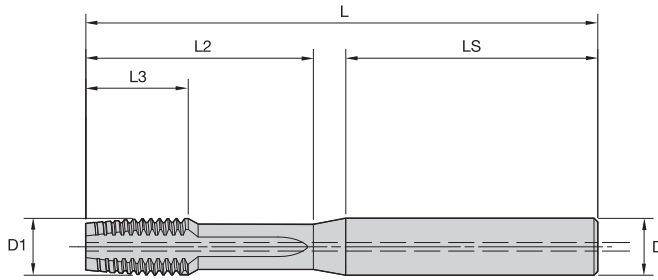
grade WH16PG TiAlN+MoS <sub>2</sub>		metric dimensions					number of flutes	dimension standard	class of fit
order #	catalogue #	D1 size	L	L3	L2	D			
4158323	GX105001	M3 X 0,5	63	6	18	4,5	4	DIN 371	6HX
4158324	GX105002	M4 X 0,7	63	8	20	4,5	4	DIN 371	6HX
4158325	GX105003	M5 X 0,8	70	10	26	6,0	4	DIN 371	6HX
4158326	GX105004	M6 X 1	80	12	28	6,0	4	DIN 371	6HX
4158331	GX105009	M8 X 1	90	15	35	8,0	5	DIN 374	6HX
4158327	GX105005	M8 X 1,25	90	15	35	8,0	5	DIN 371	6HX
4158332	GX105010	M10 X 1	100	18	38	10,0	5	DIN 374	6HX
4158328	GX105006	M10 X 1,5	100	18	38	10,0	5	DIN 371	6HX
4158333	GX105011	M12 X 1,5	110	21	41	12,0	5	DIN 374	6HX
4158329	GX105007	M12 X 1,75	110	21	41	12,0	5	DIN 376	6HX
4158334	GX105012	M14 X 1,5	110	24	44	14,0	5	DIN 374	6HX
4158330	GX105008	M14 X 2	110	24	44	14,0	6	DIN 376	6HX
4158335	GX105013	M16 X 1,5	110	24	44	16,0	5	DIN 374	6HX

High-Performance Taps





• WK12PG TiCN for cast iron.

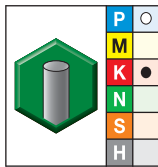


Shank Tolerance

D	tolerance h6
6	+0, -0,008
8-10	+0, -0,009
12-16	+0, -0,011



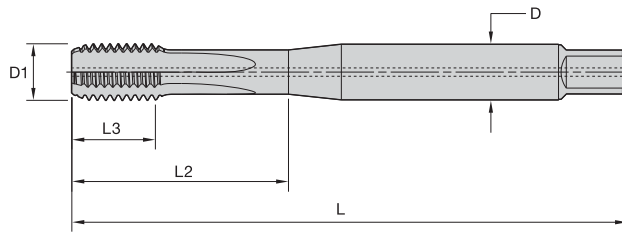
■ GX35 • Form E Bottoming Chamfer • Through Coolant M6 and Larger • Metric • For Cast Iron



● first choice  
○ alternate choice

grade WK12PG TiCN		metric dimensions						number of flutes	class of fit
order #	catalogue #	D1 size	L	L3	L2	LS	D		
5551152	GX352733	M6 X 1	70	12	24	42	6,0	4	6HX
5551153	GX352734	M8 X 1,25	80	15	32	43	8,0	4	6HX
5551154	GX352735	M10 X 1,5	90	18	40	44	10,0	4	6HX
5551156	GX352738	M12 X 1,5	100	21	48	46	12,0	4	6HX
5551155	GX352737	M12 X 1,75	100	21	48	46	12,0	4	6HX
5551159	GX352740	M14 X 1,5	110	24	56	52	12,0	4	6HX
5551157	GX352739	M14 X 2	110	24	56	52	12,0	4	6HX
5551160	GX352741	M16 X 2	110	24	64	44	14,0	4	6HX

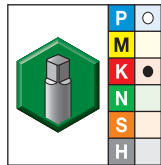
- WK12PG TiCN for cast iron.



Shank Tolerance	
D mm	tolerance h6
6	+0, -0,008
8-10	+0, -0,009
12-16	+0, -0,011



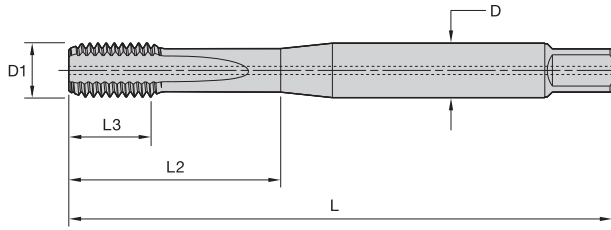
- GX35 • Form E Bottoming Chamfer • Through Coolant • Metric • For Cast Iron



- first choice
- alternate choice

grade WK12PG TiCN		metric dimensions					number of flutes	class of fit
order #	catalogue #	D1 size	L	L3	L2	D		
5520825	GX355006	M6 X 1	80	10	30	6,0	4	6HX
5520826	GX355007	M7 X 1	80	10	30	7,0	4	6HX
5520827	GX355008	M8 X 1,25	90	13	35	8,0	4	6HX
5520828	GX355009	M9 X 1,25	90	13	35	9,0	4	6HX
5520830	GX355101	M10 X 1	90	10	35	7,0	4	6HX
5520831	GX355102	M10 X 1,25	100	15	39	7,0	4	6HX
5520829	GX35510	M10 X 1,5	100	15	39	10,0	4	6HX
5520834	GX355121	M12 X 1,25	100	15	39	9,0	4	6HX
5520835	GX355122	M12 X 1,50	100	15	39	9,0	4	6HX
5520833	GX355012	M12 X 1,75	110	18	44	9,0	4	6HX
5520837	GX355141	M14 X 1,25	100	15	47	11,0	4	6HX
5520838	GX355142	M14 X 1,5	100	15	47	11,0	4	6HX
5520836	GX355014	M14 X 2	110	20	52	11,0	4	6HX

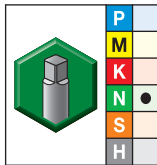
- WN14PG TiN + CrC/C for aluminium.



Shank Tolerance	
D	tolerance h6
6	+0, -0,008
8-10	+0, -0,009
12-16	+0, -0,011



■ GX47 • Form E Bottoming Chamfer • Through Coolant • Metric • For Aluminium



- first choice
- alternate choice

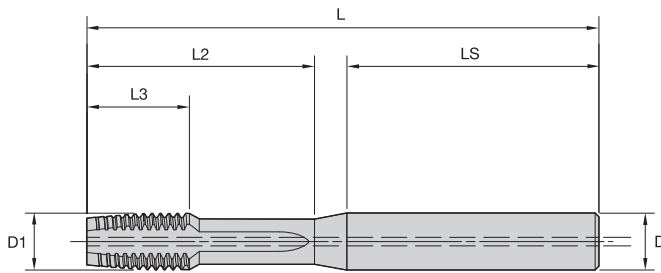
grade WN14PG TiN+CrC/C		metric dimensions					number of flutes	class of fit
order #	catalogue #	D1 size	L	L3	L2	D		
5520839	GX475006	M6 X 1	80	10	30	6,0	3	6HX
5520840	GX475008	M8 X 1,25	90	10	35	8,0	3	6HX
5520841	GX475010	M10 X 1,5	100	15	39	10,0	3	6HX

# High-Performance Taps

Victory™ Solid Carbide Straight-Flute Taps • Blind Holes



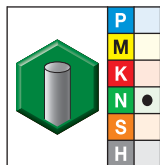
- WN14PG TiN + CrC/C for aluminium.



Shank Tolerance	
D mm	tolerance h6
6	+0, -0,008
8-10	+0, -0,009
12-16	+0, -0,011



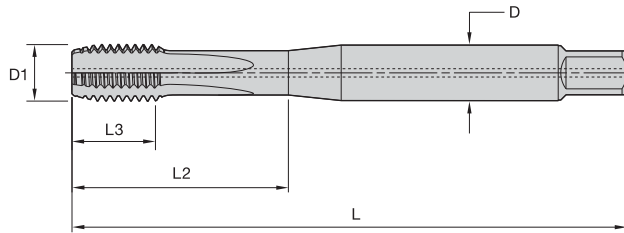
- GX47 • Form E Bottoming Chamfer • Through Coolant • Metric • For Aluminium



- first choice
- alternate choice

grade WN14PG TiN+CrC/C		metric dimensions						number of flutes	class of fit
order #	catalogue #	D1 size	L	L3	L2	LS	D		
5551161	GX472866	M6 X 1	70	12	24	42	6,0	3	6HX
5551162	GX472867	M8 X 1,25	80	15	32	43	8,0	3	6HX
5551163	GX472868	M10 X 1,5	90	18	40	44	10,0	3	6HX
5551164	GX472872	M12 X 1,5	100	21	48	46	12,0	3	6HX
5551165	GX472870	M12 X 1,75	100	21	48	46	12,0	3	6HX
5551166	GX472874	M14 X 1,5	110	24	56	52	12,0	4	6HX
5551167	GX472873	M14 X 2	110	24	56	52	12,0	4	6HX
5551168	GX472875	M16 X 2	110	24	64	44	14,0	4	6HX

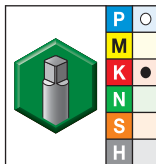
- WK12PG TiCN for cast iron.



Shank Tolerance	
D mm	tolerance h6
6	+0, -0,008
8-10	+0, -0,009
12-16	+0, -0,011



■ GX50 • Form C Semi-Bottoming Chamfer • Through Coolant M6 and Larger • Metric • For Cast Iron



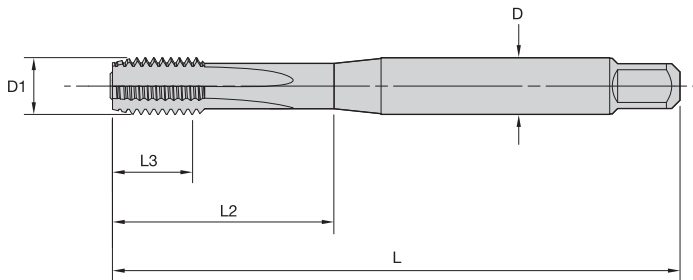
- first choice
- alternate choice

grade WK12PG TiCN		metric dimensions					number of flutes	class of fit
order #	catalogue #	D1 size	L	L3	L2	D		
5520817	GX505004	M4 X 0,7	63	10	21	4,5	3	6HX
5520818	GX505005	M5 X 0,8	70	10	25	6,0	3	6HX
5520819	GX505006	M6 X 1	80	10	30	6,0	4	6HX
5520820	GX505008	M8 X 1,25	90	13	35	8,0	4	6HX
5520822	GX505010	M10 X 1,5	100	15	39	10,0	4	6HX
5520823	GX505012	M12 X 1,75	110	18	44	9,0	4	6HX
5520824	GX505014	M14 X 2	110	20	52	11,0	4	6HX

# High-Performance Taps

Victory™ Straight-Flute HSS-E-PM Taps • Through and Blind Holes

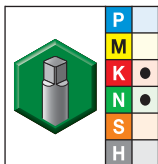
- GP6520 TiCN for cast iron and cast aluminium.



Shank Tolerance	
D mm	tolerance h6
>3-6	+0, -0,008
>6-10	+0, -0,009
>10-18	+0, -0,011
>18-30	+0, -0,013
>30-50	+0, -0,016



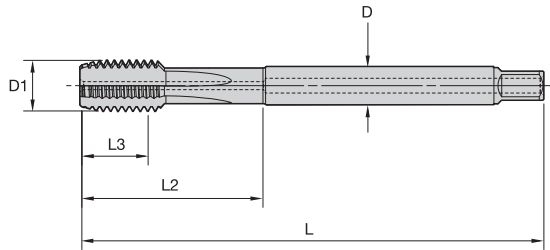
- GT40 • Form C Semi-Bottoming Chamfer • Metric DIN 371, 374, and 376 • For Cast Iron and Cast Aluminium



- first choice
- alternate choice

grade GP6520 TiCN		metric dimensions					number of flutes	dimension standard	class of fit
order #	catalogue #	D1 size	L	L3	L2	D			
4033699	GT405001	M4 X 0,7	63	10	21	4,5	3	DIN 371	6HX
4033700	GT405002	M5 X 0,8	70	10	25	6,0	3	DIN 371	6HX
4033701	GT405003	M6 X 1	80	10	30	6,0	4	DIN 371	6HX
4033702	GT405004	M8 X 1,25	90	13	35	8,0	4	DIN 371	6HX
4033753	GT405005	M10 X 1,5	100	15	39	10,0	4	DIN 371	6HX
5408066	GT405057	M12 X 1,5	100	15	39	9,0	4	DIN 374	6HX
4033754	GT405006	M12 X 1,75	110	18	44	9,0	4	DIN 376	6HX
5408067	GT405058	M14 X 1,5	100	15	47	11,0	4	DIN 374	6HX
4033755	GT405007	M14 X 2	110	20	52	11,0	4	DIN 376	6HX
5408068	GT405059	M16 X 1,5	100	15	46	12,0	4	DIN 374	6HX
4033756	GT405008	M16 X 2	110	20	51	12,0	4	DIN 376	6HX
4033757	GT405009	M18 X 2,5	125	25	58	14,0	4	DIN 376	6HX
4033758	GT405010	M20 X 2,5	140	25	64	16,0	4	DIN 376	6HX
4033759	GT405011	M22 X 2,5	140	25	70	18,0	4	DIN 376	6HX

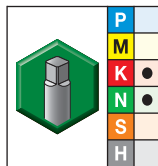
- GP6520 TiCN for cast iron and cast aluminium.



Shank Tolerance	
D mm	tolerance h6
>3-6	+0, -0,008
>6-10	+0, -0,009
>10-18	+0, -0,011
>18-30	+0, -0,013
>30-50	+0, -0,016



- GT41 • Form C Semi-Bottoming Chamfer • Through Coolant • Metric DIN 371, 374, and 376 • For Cast Iron and Cast Aluminium



- first choice
- alternate choice

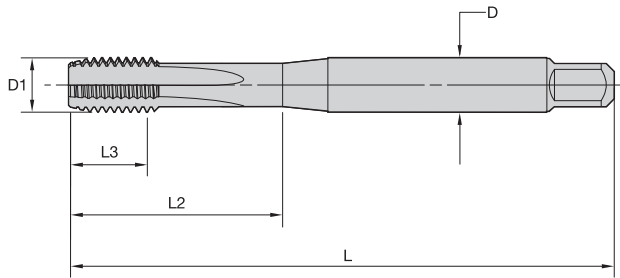
grade GP6520 TiCN		metric dimensions					number of flutes	dimension standard	class of fit
order #	catalogue #	D1 size	L	L3	L2	D			
4033659	GT415001	M4 X 0,7	63	10	21	4,5	3	DIN 371	6HX
4033660	GT415002	M5 X 0,8	70	10	25	6,0	3	DIN 371	6HX
4033661	GT415003	M6 X 1	80	10	30	6,0	4	DIN 371	6HX
4033662	GT415004	M8 X 1,25	90	13	35	8,0	4	DIN 371	6HX
4033813	GT415005	M10 X 1,5	100	15	39	10,0	4	DIN 371	6HX
5408069	GT415021	M12 X 1,5	100	15	39	9,0	4	DIN 374	6HX
4033814	GT415006	M12 X 1,75	110	18	44	9,0	4	DIN 376	6HX
5408400	GT415022	M14 X 1,5	100	15	47	11,0	4	DIN 374	6HX
4033815	GT415007	M14 X 2	110	20	52	11,0	4	DIN 376	6HX
5408401	GT415023	M16 X 1,5	100	15	46	12,0	4	DIN 374	6HX
4033816	GT415008	M16 X 2	110	20	51	12,0	4	DIN 376	6HX
4033817	GT415009	M18 X 2,5	125	25	58	14,0	4	DIN 376	6HX
4033818	GT415010	M20 X 2,5	140	25	64	16,0	4	DIN 376	6HX

# High-Performance Taps

Victory™ Straight-Flute HSS-E-PM Taps • Threading Close to the Bottom in Blind Holes



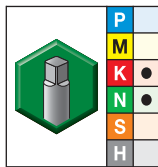
- GP6520 TiCN for cast iron and cast aluminium.



Shank Tolerance	
D mm	tolerance h6
>3-6	+0, -0,008
>6-10	+0, -0,009
>10-18	+0, -0,011
>18-30	+0, -0,013
>30-50	+0, -0,016



■ GT42 • Form E Bottoming Chamfer • Metric DIN 371, 374, and 376 • For Cast Iron and Cast Aluminium



- first choice
- alternate choice

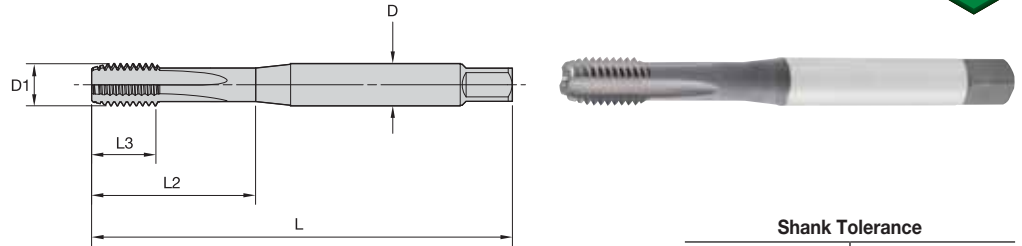
grade GP6520 TiCN		metric dimensions					number of flutes	dimension standard	class of fit
order #	catalogue #	D1 size	L	L3	L2	D			
4154274	GT425001	M5 X 0,8	70	10	25	6,0	3	DIN 371	6HX
4154275	GT425002	M6 X 1	80	10	30	6,0	4	DIN 371	6HX
4154276	GT425003	M8 X 1,25	90	13	35	8,0	4	DIN 371	6HX
4154277	GT425004	M10 X 1,5	100	15	39	10,0	4	DIN 371	6HX
4154280	GT425007	M12 X 1,5	100	15	39	9,0	4	DIN 374	6HX
4154278	GT425005	M12 X 1,75	110	18	44	9,0	4	DIN 376	6HX
4154281	GT425008	M14 X 1,5	100	15	47	11,0	4	DIN 374	6HX
4154279	GT425006	M14 X 2	110	20	52	11,0	4	DIN 376	6HX
4154282	GT425009	M16 X 1,5	100	15	46	12,0	4	DIN 374	6HX
5408402	GT425010	M16 X 2	110	20	51	12,0	4	DIN 376	6HX
5408403	GT425011	M18 X 2,5	125	25	58	14,0	4	DIN 376	6HX
5408404	GT425012	M20 X 2,5	140	25	64	16,0	4	DIN 376	6HX

High-Performance Taps





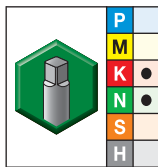
- GP6520 TiCN for cast iron and cast aluminium.



Shank Tolerance	
D mm	tolerance h6
>3-6	+0, -0,008
>6-10	+0, -0,009
>10-18	+0, -0,011
>18-30	+0, -0,013
>30-50	+0, -0,016



- GT43 • Form E Bottoming Chamfer • Through Coolant • Metric DIN 371, 374, and 376 • For Cast Iron and Cast Aluminium



- first choice
- alternate choice

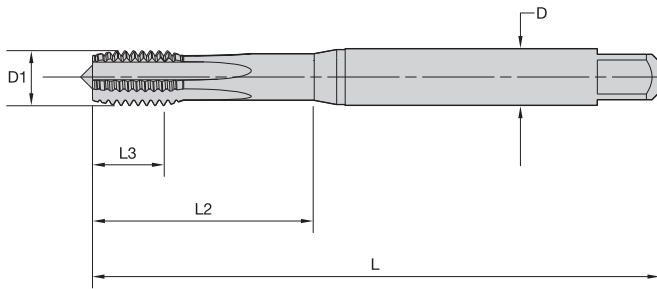
grade GP6520 TiCN		metric dimensions					number of flutes	dimension standard	class of fit
order #	catalogue #	D1 size	L	L3	L2	D			
4154283	GT435001	M5 X 0,8	70	10	25	6,0	3	DIN 371	6HX
4154284	GT435002	M6 X 1	80	10	30	6,0	4	DIN 371	6HX
4154285	GT435003	M8 X 1,25	90	13	35	8,0	4	DIN 371	6HX
4154286	GT435004	M10 X 1,5	100	15	39	10,0	4	DIN 371	6HX
4154289	GT435007	M12 X 1,5	100	15	39	9,0	4	DIN 374	6HX
4154287	GT435005	M12 X 1,75	110	18	44	9,0	4	DIN 376	6HX
4154290	GT435008	M14 X 1,5	100	15	47	11,0	4	DIN 374	6HX
4154288	GT435006	M14 X 2	110	20	52	11,0	4	DIN 376	6HX
4154291	GT435009	M16 X 1,5	100	15	46	12,0	4	DIN 374	6HX
5408405	GT435010	M16 X 2	110	20	51	12,0	4	DIN 376	6HX
5408406	GT435011	M18 X 2,5	125	25	58	14,0	4	DIN 376	6HX
5408407	GT435012	M20 X 2,5	140	25	64	16,0	4	DIN 376	6HX

# High-Performance Taps

Victory™ Straight-Flute HSS-E-PM Taps • Blind and Through Holes



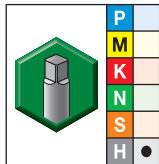
- WS32MG TiCN for steel 44–55 HRC.



Shank Tolerance	
D mm	tolerance h9
1–3	+0, -0,025
>3–6	+0, -0,030
>6–10	+0, -0,036
>10–18	+0, -0,043
>18–30	+0, -0,052

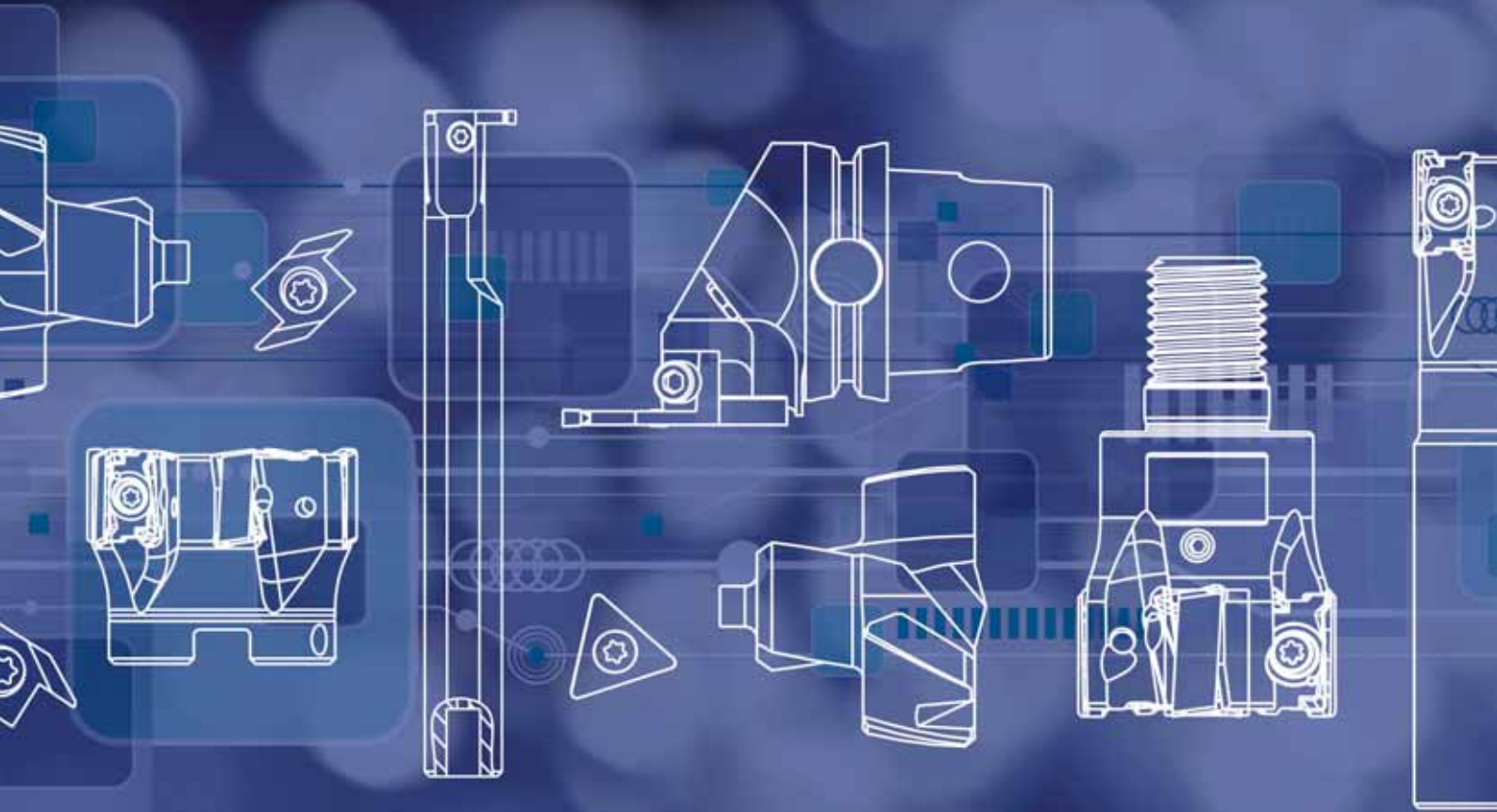


■ GT06 • Form C Semi-Bottoming Chamfer • Metric DIN 371, 374, and 376 • For Hard Steel



- first choice
- alternate choice

grade WS32MG TiCN		metric dimensions					number of flutes	dimension standard	class of fit
order #	catalogue #	D1 size	L	L3	L2	D			
4159915	GT065003	M6 X 1	80	10	30	6,0	4	DIN 371	6HX
4159918	GT065006	M8 X 1	90	10	35	8,0	5	DIN 374	6HX
4159913	GT065001	M8 X 1,25	90	14	35	8,0	5	DIN 371	6HX
4159919	GT065007	M10 X 1	90	10	35	10,0	5	DIN 374	6HX
4159914	GT065002	M10 X 1,5	100	16	39	10,0	5	DIN 371	6HX
4159920	GT065008	M12 X 1,5	100	15	—	9,0	5	DIN 374	6HX
4159916	GT065004	M12 X 1,75	110	18	—	9,0	5	DIN 376	6HX
4159921	GT065009	M14 X 1,5	100	15	—	11,0	6	DIN 374	6HX
4159922	GT065010	M16 X 1,5	100	15	—	12,0	6	DIN 374	6HX
4159917	GT065005	M16 X 2	110	22	—	12,0	6	DIN 376	6HX



## NOVO KNOWS ART TO PART TO PROFIT

Being as productive and profitable as possible is your fundamental goal. With the addition of NOVO™ to your team, your goal can be achieved. NOVO possesses powerful digital tools that link together process planning, inventory availability and purchase, cost-per-part management, and productivity improvements.

NOVO can ensure you have the right tools on your machines, in the right sequence. Resulting in flawless execution that accelerates every job, and maximises every shift. [widia.com/novo](http://widia.com/novo)

**01**

THE DIGITAL SOURCE FOR DELIVERING SMART MACHINING SOLUTIONS

[widia.com/novo](http://widia.com/novo)**NOVO**™ 

Solutions for Forming Threads in Through and Blind Hole Applications •

**WIDIA-GTD™**

# Forming Taps



WIDIA-GTD™ offers a wide range of forming tap options for tapping through and blind holes in:

- Steel and steel alloys.
- Stainless steel.
- Aluminium.

## High-Performance Victory™ Solid Carbide Taps

- Advanced forming geometries designed for superior tap performance in aluminium.
- Manufactured with fine-grain micrograin carbide for exceptional wear life.
- Ideal for long production runs where fewer tool changes mean greater productivity.
- Runs up to 4x faster and lasts up to 4x longer than conventional high-speed steel taps.
- Excellent thread quality and tap performance.

## High-Performance Victory™ HSS-E-PM Taps

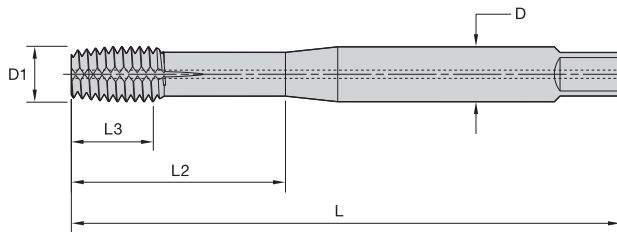
- Manufactured from powdered metal high-speed steel coated for thread forming in steel, stainless steel, and aluminium.
- High hardness provides superior wear resistance.
- Offer performance advantages over conventional high-speed steel taps.
- Long tap life at up to 50% higher tapping speed than HSS taps.



# High-Performance Taps

Victory™ Solid Carbide Forming Taps • Blind Holes

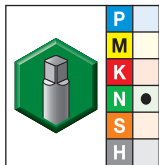
- WN14PG TiN + CrC/C for aluminium.



Shank Tolerance	
D mm	tolerance h6
6	+0, -0,008
8-10	+0, -0,009
12-16	+0, -0,011



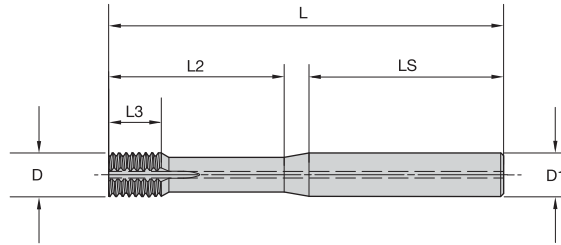
■ GX49 • Form E Bottoming Entry Taper • Through Coolant • Metric • For Aluminium



- first choice
- alternate choice

grade WN14PG TiN+CrC/C		metric dimensions					number of lube grooves	class of fit
order #	catalogue #	D1 size	L	L3	L2	D		
5520842	GX495006	M6 X 1	80	10	30	6,0	2	6HX
5520843	GX495008	M8 X 1,25	90	13	35	8,0	2	6HX
5520844	GX495010	M10 X 1,5	100	15	39	10,0	3	6HX

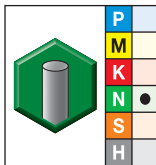
• WN14PG TiN + CrC/C  
for aluminium.



Shank Tolerance	
D	tolerance h6
6	+0, -0,008
8-10	+0, -0,009
12-16	+0, -0,011



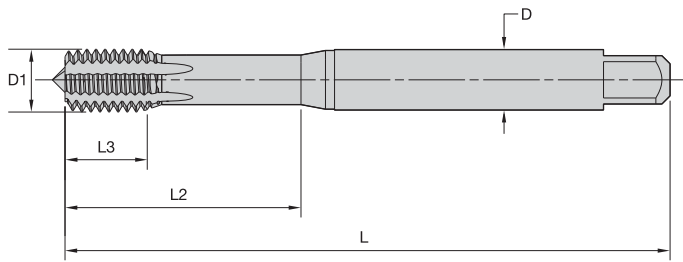
■ GX49 • Form E Bottoming Entry Taper • Through Coolant • Metric • For Aluminium



● first choice  
○ alternate choice

grade WN14PG TiN+CrC/C		metric dimensions						number of lube grooves	class of fit
order #	catalogue #	D1 size	L	L3	L2	LS	D		
5551169	GX492908	M6 X 1	70	8	24	42	6,0	2	6HX
5551170	GX492909	M8 X 1,25	80	10	32	43	8,0	2	6HX
5551171	GX492911	M10 X 1,5	90	12	40	44	10,0	3	6HX
5551173	GX492915	M12 X 1,5	100	14	48	46	12,0	3	6HX
5551172	GX492914	M12 X 1,75	100	14	48	46	12,0	3	6HX

- WP31MG TiN for steel.
- WN38MG DLC for aluminium.

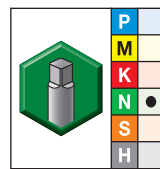
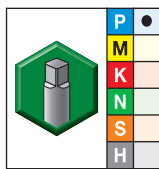


Shank Tolerance

D mm	tolerance h9
1-3	+0, -0,025
>3-6	+0, -0,030
>6-10	+0, -0,036
>10-18	+0, -0,043
>18-30	+0, -0,052



### ■ GT22 • Form C Semi-Bottoming Entry Taper • Metric DIN 2174 • For Steel and Aluminium

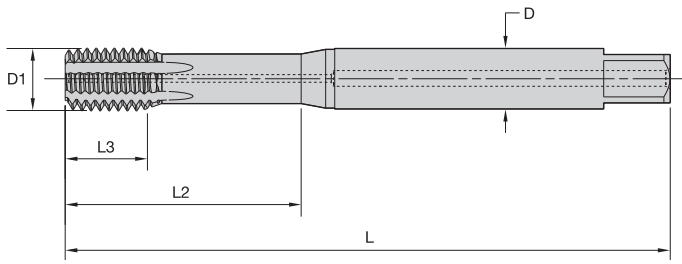


- first choice
- alternate choice

grade WP31MG TiN		grade WN38MG DLC		metric dimensions					dimension standard	class of fit
order #	catalogue #	order #	catalogue #	D1 size	L	L3	L2	D		
4158495	GT225016	4154671	GT225001	M3 X 0,5	56	6	18	3,5	DIN 2174	6HX
4158496	GT225017	4154672	GT225002	M4 X 0,7	63	7	21	4,5	DIN 2174	6HX
4158497	GT225018	4154673	GT225003	M5 X 0,8	70	8	25	6,0	DIN 2174	6HX
4158498	GT225019	4154674	GT225004	M6 X 1	80	10	30	6,0	DIN 2174	6HX
4158513	GT225024	4154679	GT225009	M8 X 1	90	10	35	8,0	DIN 2174	6HX
4158499	GT225020	4154675	GT225005	M8 X 1,25	90	14	35	8,0	DIN 2174	6HX
4158514	GT225025	4154680	GT225010	M10 X 1	90	10	35	10,0	DIN 2174	6HX
4158515	GT225026	4154681	GT225011	M10 X 1,25	100	16	39	10,0	DIN 2174	6HX
4158500	GT225021	4154676	GT225006	M10 X 1,5	100	16	39	10,0	DIN 2174	6HX
4158516	GT225027	4154682	GT225012	M12 X 1,25	100	15	—	9,0	DIN 2174	6HX
4158517	GT225028	4154683	GT225013	M12 X 1,5	100	15	—	9,0	DIN 2174	6HX
4158501	GT225022	4154677	GT225007	M12 X 1,75	110	18	—	9,0	DIN 2174	6HX
4158518	GT225029	4154684	GT225014	M14 X 1,5	100	15	—	11,0	DIN 2174	6HX
4158519	GT225030	4154685	GT225015	M16 X 1,5	100	15	—	12,0	DIN 2174	6HX
4158502	GT225023	4154678	GT225008	M16 X 2	110	22	—	12,0	DIN 2174	6HX



- WP31MG TiN for steel.
- WN38MG DLC for aluminium.

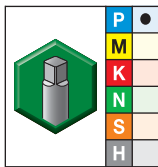


Shank Tolerance

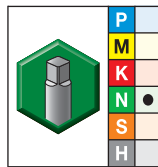
D mm	tolerance h9
1-3	+0, -0,025
>3-6	+0, -0,030
>6-10	+0, -0,036
>10-18	+0, -0,043
>18-30	+0, -0,052



■ **GT23 • Form C Semi-Bottoming Entry Taper • Through Coolant • Metric DIN 2174 • For Steel and Aluminium**



grade WP31MG  
TiN



grade WN38MG  
DLC

- first choice
- alternate choice

order #	catalogue #	order #	catalogue #	metric dimensions					dimension standard	class of fit
				D1 size	L	L3	L2	D		
4159965	GT235012	4159522	GT235001	M5 X 0,8	70	8	25	6,0	DIN 2174	6HX
4159966	GT235013	4159644	GT235002	M6 X 1	80	10	30	6,0	DIN 2174	6HX
4159971	GT235018	4159649	GT235007	M8 X 1	90	10	35	8,0	DIN 2174	6HX
4159967	GT235014	4159645	GT235003	M8 X 1,25	90	14	35	8,0	DIN 2174	6HX
4159972	GT235019	4159650	GT235008	M10 X 1	90	10	35	10,0	DIN 2174	6HX
4159968	GT235015	4159646	GT235004	M10 X 1,5	100	16	39	10,0	DIN 2174	6HX
4159993	GT235020	4159651	GT235009	M12 X 1,5	100	15	—	9,0	DIN 2174	6HX
4159969	GT235016	4159647	GT235005	M12 X 1,75	110	18	—	9,0	DIN 2174	6HX
4159994	GT235021	4159652	GT235010	M14 X 1,5	100	15	—	11,0	DIN 2174	6HX
4159995	GT235022	4159653	GT235011	M16 X 1,5	100	15	—	12,0	DIN 2174	6HX
4159970	GT235017	4159648	GT235006	M16 X 2	110	22	—	12,0	DIN 2174	6HX

Thread Mills •  
**WIDIA-GTD™**

# Thread Mills

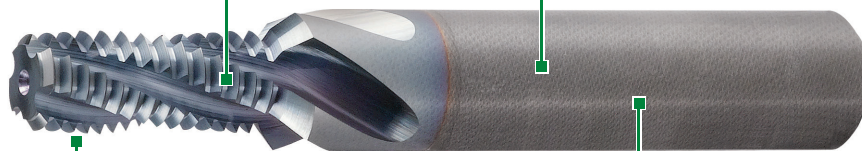


Our solid thread mills are designed to be the highest quality thread milling solution.

- Cut up to 63 HRC.
- Improved overall thread quality.

**Optimised flute design**  
Better chip evacuation.

**Carbide substrate**  
Higher heat resistance,  
higher speed.



**Various multilayer coatings**  
Extremely high wear resistance,  
longer tool life.

**Cylindrical h6 shank**  
Low runout, higher  
quality threads.

## Unmatched Capabilities

- Capable of easily cutting most difficult materials.
- Carbide grades make threading easier and reduce machining times.
- High-quality internal and external threading on 3-axis CNC machines.
- Thread mills make interrupted cuts and short chips.
- Design offers a range of benefits to improve overall thread quality.
- Short, easily evacuated chips generate less heat and friction, so there is a lower risk of damage to threading.





















## Choose WIDIA-GTD™ Thread Mills

- Greater versatility than competitive products.
- Optimum surface quality for an excellent end product.
- Designed to eliminate chipping issues.
- No need to reverse the spindle.
- Fewer machining problems means more production safety.















**Victory™ GTM Series HP Solid Carbide Thread Mills • Metric**

- ★ Good
- ★★ Better
- ★★★ Best

GTM Series Solid Thread Milling • Metric	series	size range	hole	operation	coolant	grade	shank
		(inch and metric)					
	GTM11	M3–M20				WU13PV	6535 HA
	GTM21	M5–M16				WU12PV	6535 HA
	GTM31	M4–M16				WU12PV	6535 HA
	GTM41	M6–M24				WU16PV	6535 HA
	GTM41LH	M6–M12				WU16PV	6535 HA

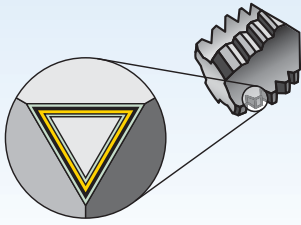
**Victory GTM Series HP Solid Carbide Thread Mills • Inch**

- ★ Good
- ★★ Better
- ★★★ Best

GTM Series Solid Thread Milling • Inch	series	size range	hole	operation	coolant	grade	shank
		(inch and metric)					
	GTM21	#10–5/8"				WU12PV	6535 HA
	GTM31	1/4–5/8"				WU12PV	6535 HA
	GTM41	1/4–3/4"				WU16PV	6535 HA

P				M	K		N			S				H		page(s)	recommended cutting parameters
1, 2, 3, 4, 6, 7	5, 9, 10, 11	12, 13.1	13.2	14.1, 14.2, 14.3, 14.4	15, 16, 17, 18, 19	20	21	22, 23, 24, 25	26, 27, 28	31, 32	33, 34, 35	36	37	38.1, 38.2, 40.1, 40.2, 41.1	39.1, 41.2		
Steel <35 HRC	Steel 36-48 HRC	PH and Ferritic Stainless Steel <35 HRC	PH and Ferritic Stainless Steel >35 HRC	Stainless Steel	Cast Iron		Wrought Aluminium	Cast Aluminium	Copper, Copper Alloys	Iron Based	Cobalt Based	Nickel Based	Titanium Alloys	Hardened Steels 49-55 HRC	Hardened Steels 56-68 HRC		
★ ★ ★	★ ★ ★	★ ★ ★	★ ★ ★	★ ★ ★	★ ★ ★	★ ★ ★	★ ★ ★	★ ★ ★	★ ★ ★	★	★	★	★			Y69	Y77
★ ★ ★	★ ★ ★	★ ★ ★	★ ★ ★	★ ★ ★	★ ★ ★	★ ★ ★	★ ★ ★	★ ★ ★	★ ★ ★	★ ★ ★	★ ★ ★	★ ★ ★	★ ★ ★			Y71	Y77
					★ ★ ★	★ ★ ★	★ ★ ★	★ ★ ★	★ ★ ★							Y73	Y77
★ ★ ★	★ ★ ★	★ ★ ★	★ ★ ★	★ ★ ★	★ ★ ★	★ ★ ★	★ ★ ★	★ ★ ★	★ ★ ★					★ ★ ★	★ ★ ★	Y75	Y78
										★ ★ ★	★ ★ ★	★ ★ ★	★ ★ ★	★ ★ ★	★ ★ ★	Y76	Y78

P				M	K		N			S				H		page(s)	recommended cutting parameters
1, 2, 3, 4, 6, 7	5, 9, 10, 11	12, 13.1	13.2	14.1, 14.2, 14.3, 14.4	15, 16, 17, 18, 19	20	21	22, 23, 24, 25	26, 27, 28	31, 32	33, 34, 35	36	37	38.1, 38.2, 40.1, 40.2, 41.1	39.1, 41.2		
Steel <35 HRC	Steel 36-48 HRC	PH and Ferritic Stainless Steel <35 HRC	PH and Ferritic Stainless Steel >35 HRC	Stainless Steel	Cast Iron		Wrought Aluminium	Cast Aluminium	Copper, Copper Alloys	Iron Based	Cobalt Based	Nickel Based	Titanium Alloys	Hardened Steels 49-55 HRC	Hardened Steels 56-68 HRC		
★ ★ ★	★ ★ ★	★ ★ ★	★ ★ ★	★ ★ ★	★ ★ ★	★ ★ ★	★ ★ ★	★ ★ ★	★ ★ ★	★ ★ ★	★ ★ ★	★ ★ ★	★ ★ ★			Y70	Y77
					★ ★ ★	★ ★ ★	★ ★ ★	★ ★ ★	★ ★ ★							Y72	Y77
★ ★ ★	★ ★ ★	★ ★ ★	★ ★ ★	★ ★ ★	★ ★ ★	★ ★ ★	★ ★ ★	★ ★ ★	★ ★ ★					★ ★ ★	★ ★ ★	Y74	Y78

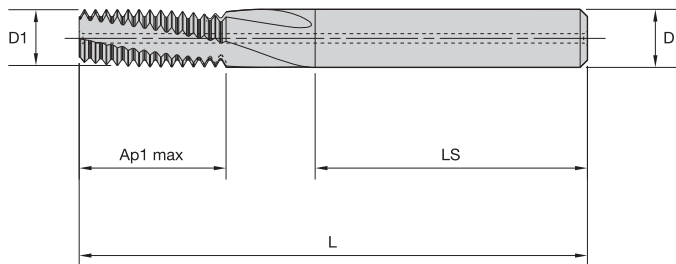
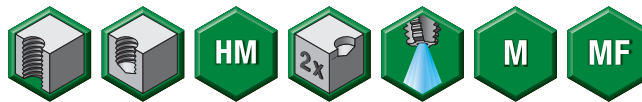


Coatings are designed for optimised tapping performance in specific materials.

<b>P</b>	Steel
<b>M</b>	Stainless Steel
<b>K</b>	Cast Iron
<b>N</b>	Non-Ferrous
<b>S</b>	High-Temp Alloys
<b>H</b>	Hardened Materials

wear resistance ← → toughness

Grade	Coating	Grade Description		Material Group																		
				05	10	15	20	25	30	35	40	45										
WU12PV		Coated carbide. PVD fine-grain carbide substrate with high-hardness TiCN coating. Universal grade for thread milling most materials.	<b>P</b>																			
			<b>M</b>																			
			<b>K</b>																			
			<b>N</b>																			
			<b>S</b>																			
WU13PV		Coated carbide. PVD carbide substrate with heat-resistant TiAlN coating. Universal grade for thread milling most materials.	<b>P</b>																			
			<b>M</b>																			
			<b>K</b>																			
			<b>N</b>																			
			<b>S</b>																			
WU16PV		Coated carbide. PVD two-layer coating with heat-resistant TiAlN base layer and low-friction MoS <sub>2</sub> top layer over carbide substrate. Use for thread milling most materials, including high-hardness materials.	<b>P</b>																			
			<b>M</b>																			
			<b>K</b>																			
			<b>N</b>																			
			<b>S</b>																			
			<b>H</b>																			

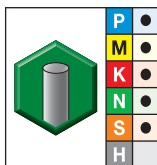


Shank Tolerance

D mm	tolerance h6
6	+0, -0,008
8-10	+0, -0,009
12-18	+0, -0,011
20-30	+0, -0,013



■ GTM11 • Through Coolant • Metric and Metric Fine



- first choice
- alternate choice

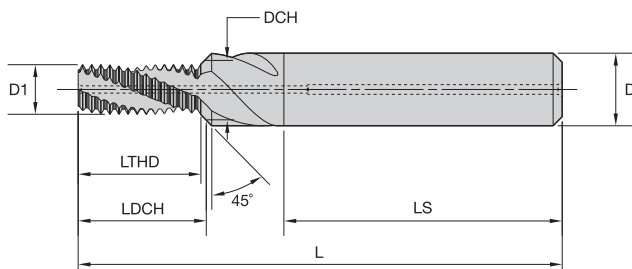
grade WU13PV  
TiAlN

metric dimensions

cutting  
edges

order #	catalogue #	D1 size	D1	Ap1 max	L	LS	D	cutting edges
4138391	GTM115001	M3X0.5	2,4	6	42	28	4,0	3
4138502	GTM115012	M4X0.5	3,4	8	55	36	6,0	3
4138392	GTM115002	M4X0.7	3,2	9	55	36	6,0	3
4138503	GTM115013	M5X0.5	4,3	10	55	36	6,0	3
4138493	GTM115003	M5X0.8	4,0	11	55	36	6,0	3
4138504	GTM115014	M6X0.75	5,0	12	55	36	6,0	3
4138494	GTM115004	M6X1	4,8	12	55	36	6,0	3
4138505	GTM115015	M8X0.75	5,9	17	63	36	6,0	3
4138506	GTM115016	M8X1	5,9	16	63	36	6,0	3
4138495	GTM115005	M8X1.25	5,9	17	63	36	6,0	3
4138507	GTM115017	M10X1	7,9	20	70	36	8,0	3
4138496	GTM115006	M10X1.5	7,9	20	70	36	8,0	3
4138508	GTM115018	M12X1	9,9	24	80	40	10,0	4
4138509	GTM115019	M12X1.5	9,9	25	80	40	10,0	4
4138497	GTM115007	M12X1.75	9,9	25	80	40	10,0	4
4138510	GTM115020	M14X1.5	9,9	29	80	40	10,0	4
4138498	GTM115008	M14X2	11,6	29	90	45	12,0	4
4138511	GTM115021	M16X1.5	11,9	32	90	45	12,0	4
4138499	GTM115009	M16X2	11,9	33	90	45	12,0	4
4138512	GTM115022	M18X1.5	13,9	37	90	45	14,0	4
4138500	GTM115010	M18X2.5	13,9	39	90	45	14,0	4
4138513	GTM115023	M20X1.5	13,9	41	90	45	14,0	4
4138501	GTM115011	M20X2.5	13,9	41	90	45	14,0	4

High-Performance Thread Mills

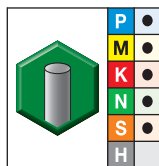


Shank Tolerance

D mm	tolerance h6
6	+0, -0,008
8-10	+0, -0,009
12-18	+0, -0,011
20-30	+0, -0,013



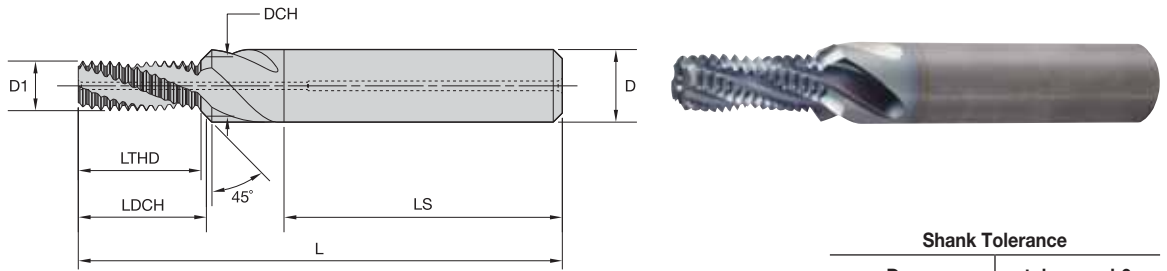
■ GTM21 • Through Coolant • Inch UNC and UNF



● first choice  
○ alternate choice

grade WU12PV TiCN		metric dimensions								cutting edges
order #	catalogue #	D1 TPI	D1	DCH	LTHD	LDCH	L	LS	D	
4138537	GTM215024	#10-32	3,8	5,13	9,95	10,53	55	36	6,0	3
4138530	GTM215017	1/4-20	4,7	6,65	13,36	14,23	62	36	8,0	3
4138538	GTM215025	1/4-28	5,2	6,65	13,19	13,84	62	36	8,0	3
4138531	GTM215018	5/16-18	6,2	8,25	16,26	17,19	74	40	10,0	3
4138539	GTM215026	5/16-24	6,6	8,25	16,44	17,15	74	40	10,0	3
4138532	GTM215019	3/8-16	7,7	9,83	19,89	20,85	80	45	12,0	3
4138540	GTM215027	3/8-24	8,2	9,83	19,62	20,31	80	45	12,0	3
4138533	GTM215020	7/16-14	9,0	11,43	22,72	23,79	80	45	12,0	3
4138541	GTM215028	7/16-20	9,6	11,43	22,28	23,08	80	45	12,0	3
4138534	GTM215021	1/2-13	10,4	13,00	26,43	27,60	90	45	14,0	4
4138542	GTM215029	1/2-20	11,1	13,00	26,10	26,89	90	45	14,0	4
4138535	GTM215022	9/16-12	11,8	14,61	30,75	31,99	100	48	16,0	4
4138543	GTM215030	9/16-18	12,5	14,61	28,99	29,88	100	48	16,0	4
4138536	GTM215023	5/8-11	13,1	16,18	33,54	34,89	102	48	18,0	4
4138544	GTM215031	5/8-18	14,1	16,18	33,24	34,09	102	48	18,0	4

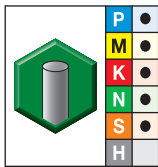




Shank Tolerance	
D mm	tolerance h6
6	+0, -0,008
8-10	+0, -0,009
12-18	+0, -0,011
20-30	+0, -0,013



■ GTM21 • Through Coolant • Metric and Metric Fine

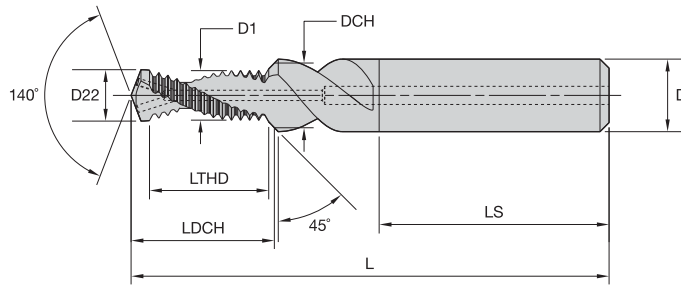


● first choice  
○ alternate choice

grade WU12PV TiCN		metric dimensions								cutting edges
order #	catalogue #	D1 size	D1	DCH	LTHD	LDCH	L	LS	D	
4138514	GTM215001	M5X0.8	4,0	5,30	10,82	11,40	55	36	6,0	3
4138521	GTM215008	M6X0.75	5,0	6,30	12,40	12,97	62	36	8,0	3
4138515	GTM215002	M6X1	4,8	6,30	12,52	13,19	62	36	8,0	3
4138522	GTM215009	M8X1	6,7	8,30	16,53	17,23	74	40	10,0	3
4138516	GTM215003	M8X1.25	6,5	8,30	16,91	17,71	74	40	10,0	3
4138523	GTM215010	M10X1	8,7	10,30	20,55	21,23	80	45	12,0	3
4138524	GTM215011	M10X1.25	8,4	10,30	20,67	21,50	80	45	12,0	3
4138517	GTM215004	M10X1.5	8,2	10,30	20,29	21,22	80	45	12,0	3
4138525	GTM215012	M12X1	10,6	12,30	24,56	25,27	90	45	14,0	4
4138526	GTM215013	M12X1.25	10,4	12,30	24,43	25,24	90	45	14,0	4
4138527	GTM215014	M12X1.5	10,1	12,30	24,80	25,76	90	45	14,0	4
4138518	GTM215005	M12X1.75	9,9	12,30	25,42	26,48	90	45	14,0	4
4138528	GTM215015	M14X1.5	12,1	14,30	29,31	30,25	100	48	16,0	4
4138519	GTM215006	M14X2	11,6	14,30	29,05	30,24	100	48	16,0	4
4138529	GTM215016	M16X1.5	14,0	16,30	32,31	33,30	102	48	18,0	4
4138520	GTM215007	M16X2	13,6	16,30	33,05	34,24	102	48	18,0	4

# High-Performance Thread Mills

Victory™ Solid Carbide Thread Mills • Blind and Through Holes

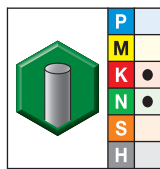


Shank Tolerance

D mm	tolerance h6
6	+0, -0,008
8-10	+0, -0,009
12-18	+0, -0,011
20-30	+0, -0,013



■ GTM31 • Through Coolant • Inch UNC and UNF



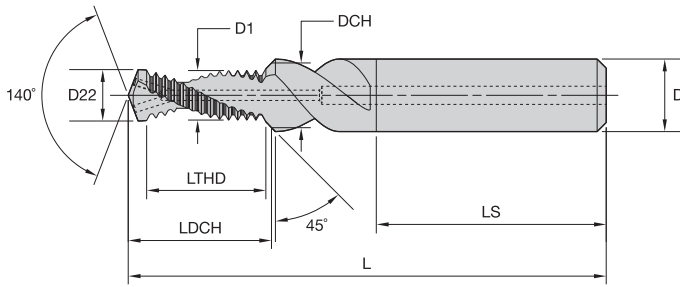
- first choice
- alternate choice

grade WU12PV  
TiCN

metric dimensions

order #	catalogue #	D1 TPI	D1	D22	DCH	LTHD	LDCH	L	LS	D	cutting edges
4138561	GTM315021	1/4-20	4,9	5,2	6,65	12,80	15,87	62	36	8,0	2
4138568	GTM315028	1/4-28	5,3	5,5	6,65	12,79	15,35	62	36	8,0	2
4138562	GTM315023	5/16-18	6,3	6,6	8,25	15,63	19,19	74	40	10,0	2
4138569	GTM315030	5/16-24	6,6	6,9	8,25	15,98	19,07	74	40	10,0	2
4138563	GTM315017w	3/8-16	7,7	8,0	9,83	19,16	23,25	79	45	12,0	2
4138570	GTM315024	3/8-24	8,2	8,5	9,83	19,16	22,54	79	45	12,0	2
4138564	GTM315018	7/16-14	9,0	9,4	11,43	21,89	26,58	79	45	12,0	2
4138571	GTM315025	7/16-20	9,6	9,9	11,43	21,72	25,69	79	45	12,0	2
4138565	GTM315019	1/2-13	10,4	10,8	13,00	25,52	30,71	89	45	14,0	2
4138572	GTM315026	1/2-20	11,1	11,5	13,00	25,55	29,82	89	45	14,0	2
4138566	GTM315020	9/16-12	11,8	12,3	14,61	27,66	33,37	102	48	16,0	2
4138573	GTM315027	9/16-18	12,5	12,9	14,61	28,37	33,15	102	48	16,0	2
4138567	GTM315022	5/8-11	13,1	13,5	16,18	30,14	36,40	102	48	18,0	2
4138574	GTM315029	5/8-18	14,1	14,5	16,18	31,21	36,25	102	48	18,0	2

High-Performance Thread Mills

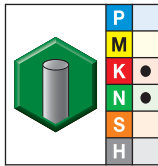


Shank Tolerance

D mm	tolerance h6
6	+0, -0,008
8-10	+0, -0,009
12-18	+0, -0,011
20-30	+0, -0,013

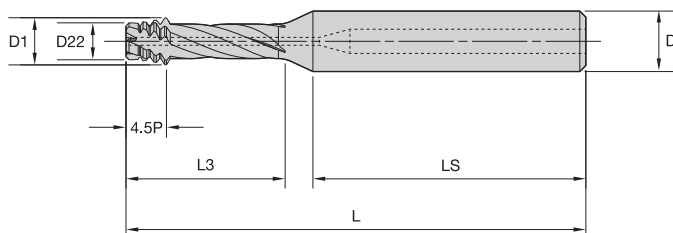


■ GTM31 • Through Coolant • Metric and Metric Fine



- first choice
- alternate choice

grade WU12PV TiCN		metric dimensions									cutting edges
order #	catalogue #	D1 size	D1	D22	DCH	LTHD	LDCH	L	LS	D	
4138545	GTM315001	M4X0.7	3,2	3,3	4,30	7,74	9,59	49	36	6,0	2
4138546	GTM315002	M5X0.8	4,0	4,2	5,30	9,65	11,82	55	36	6,0	2
4138553	GTM315009	M6X0.75	5,1	5,3	6,30	12,07	14,37	62	36	8,0	2
4138547	GTM315003	M6X1	4,8	5,0	6,30	12,06	14,69	62	36	8,0	2
4138554	GTM315010	M8X1	6,8	7,0	8,30	16,09	19,10	74	40	10,0	2
4138548	GTM315004	M8X1.25	6,5	6,8	8,30	15,08	18,42	74	40	10,0	2
4138555	GTM315011	M10X1	8,7	9,0	10,30	20,11	23,52	79	45	12,0	2
4138556	GTM315012	M10X1.25	8,4	8,8	10,30	20,11	23,87	79	45	12,0	2
4138549	GTM315005	M10X1.5	8,2	8,5	10,30	19,59	23,65	79	45	12,0	2
4138557	GTM315013	M12X1.25	10,4	10,8	12,30	23,88	28,00	89	45	14,0	2
4138558	GTM315014	M12X1.5	10,2	10,5	12,30	24,12	28,57	89	45	14,0	2
4138550	GTM315006	M12X1.75	9,9	10,3	12,30	22,86	27,63	89	45	14,0	2
4138559	GTM315015	M14X1.5	12,1	12,5	14,30	27,14	31,98	102	48	16,0	2
4138551	GTM315007	M14X2	11,6	12,0	14,30	28,12	33,62	102	48	16,0	2
4138560	GTM315016	M16X1.5	14,1	14,5	16,30	31,65	36,87	102	48	18,0	2
4138552	GTM315008	M16X2	13,6	14,0	16,30	32,13	38,00	102	48	18,0	2

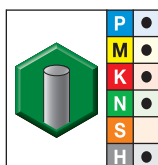


Shank Tolerance

D mm	tolerance h6
6	+0, -0,008
8-10	+0, -0,009
12-18	+0, -0,011
20-30	+0, -0,013

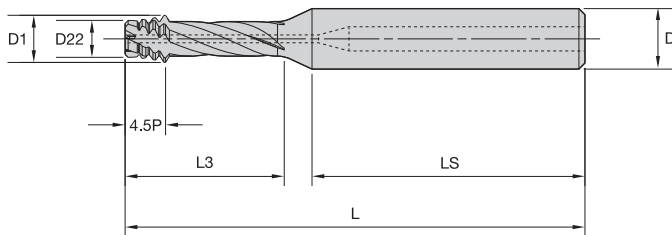


■ GTM41 • Through Coolant • Right Hand • Inch UNC and UNF



● first choice  
○ alternate choice

grade WU16PV TiAlN+MoS <sub>2</sub>		metric dimensions							cutting edges
order #	catalogue #	D1 TPI	D1	D22	L3	L	LS	D	
4138610	GTM415025	1/4-20	4,64	3,34	17,00	60	36	8,0	3
4138617	GTM415033	1/4-28	4,66	3,62	17,00	60	36	8,0	3
4138611	GTM415026	5/16-18	5,64	4,12	21,90	76	40	10,0	4
4138618	GTM415034	5/16-24	5,64	4,48	21,90	76	40	10,0	4
4138612	GTM415027	3/8-16	7,16	5,42	26,30	76	40	10,0	4
4138619	GTM415035	3/8-24	7,14	6,00	26,30	76	40	10,0	4
4138613	GTM415028	7/16/14	8,47	6,49	31,00	86	45	12,0	4
4138620	GTM415036	7/16-20	8,45	7,06	33,00	86	45	12,0	4
4138606	GTM415029	1/2-13	10,08	7,95	33,40	86	45	12,0	4
4138615	GTM415037	1/2-20	8,45	7,06	33,00	86	45	12,0	4
4138614	GTM415030	9/16-12	11,28	8,98	41,00	98	48	16,0	4
4138621	GTM415038	9/16-18	11,27	9,72	41,00	98	48	16,0	4
4138607	GTM415031	5/8-11	12,89	10,40	42,00	98	48	16,0	4
4138616	GTM415039	5/8-18	12,38	10,83	42,00	98	48	16,0	4
4138608	GTM415032	3/4-10	15,50	12,77	51,30	111	50	20,0	5
4138609	GTM415040	3/4-16	15,38	13,65	51,30	111	50	20,0	5

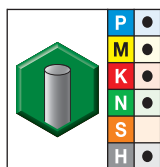


Shank Tolerance

D mm	tolerance h6
6	+0, -0,008
8-10	+0, -0,009
12-18	+0, -0,011
20-30	+0, -0,013



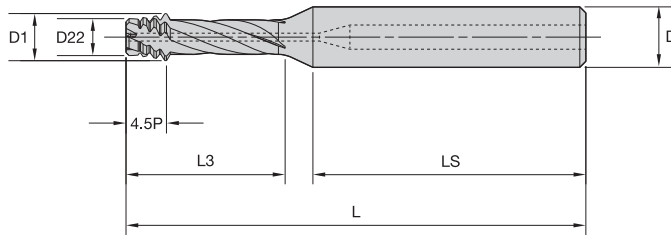
■ GTM41 • Through Coolant • Right Hand • Metric and Metric Fine



● first choice  
○ alternate choice

grade WU16PV TiAlN+MoS <sub>2</sub>		metric dimensions							cutting edges
order #	catalogue #	D1 size	D1	D22	L3	L	LS	D	
4138576	GTM415001	M6X1	4,51	3,41	16,5	60	36	8,0	3
4138578	GTM415002	M7X1	4,51	3,41	16,5	60	36	8,0	3
4138592	GTM415014	M8X1	6,23	5,13	21,9	71	40	10,0	4
4138580	GTM415003	M8X1.25	6,23	4,91	21,9	71	40	10,0	4
4138593	GTM415015	M9X1	6,23	5,13	21,9	71	40	10,0	4
4138582	GTM415004	M9X1.25	6,23	4,91	21,9	71	40	10,0	4
4138594	GTM415016	M10X1	6,23	5,13	21,9	71	40	10,0	4
4138595	GTM415013	M10X1.25	6,23	4,91	21,9	71	40	10,0	4
4138584	GTM415005	M10X1.5	7,75	6,11	26,3	76	40	10,0	4
4138586	GTM415006	M11X1.5	7,75	6,11	26,3	76	40	10,0	4
4138596	GTM415017	M12X1	9,15	8,06	30,0	86	45	12,0	4
4138598	GTM415007	M12X1.5	7,75	6,11	26,3	76	40	10,0	4
4138587	GTM415008	M12X1.75	9,16	7,21	32,4	86	45	12,0	4
4138599	GTM415018	M14X1	9,15	8,06	30,0	86	45	12,0	4
4138600	GTM415019	M14X1.5	10,83	9,15	37,4	98	48	16,0	4
4138588	GTM415009	M14X2	11,08	8,91	41,0	98	48	16,0	4
4138601	GTM415020	M16X1.5	10,83	9,15	37,4	98	48	16,0	4
4138589	GTM415010	M16X2	11,08	8,91	41,0	98	48	16,0	4
4138602	GTM415021	M18X1.5	14,83	13,15	47,0	98	48	16,0	4
4138590	GTM415011	M18X2.5	14,38	11,71	51,3	111	50	20,0	5
4138603	GTM415022	M20X1.5	14,83	13,15	47,0	98	48	16,0	4
4138591	GTM415012	M20X2.5	14,38	11,71	51,3	111	50	20,0	5
4138604	GTM415023	M22X1.5	18,23	16,55	56,0	111	50	20,0	5
4138605	GTM415024	M24X1.5	18,23	16,55	56,0	111	50	20,0	5

High-Performance Thread Mills

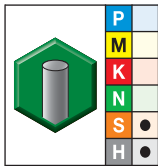


Shank Tolerance

D mm	tolerance h6
6	+0, -0,008
8-10	+0, -0,009
12-18	+0, -0,011
20-30	+0, -0,013





■ GTM41 • Through Coolant • Left Hand • Metric and Metric Fine




- first choice
- alternate choice

grade WU16PV TiAlN+MoS <sub>2</sub>		metric dimensions							cutting edges
order #	catalogue #	D1 size	D1	D22	L3	L	LS	D	
4138575	GTM415041	M6X1	4,51	3,41	16,5	60	36	8,0	3
4138577	GTM415042	M7X1	4,51	3,41	16,5	60	36	8,0	3
4138579	GTM415043	M8X1.25	6,23	4,91	21,9	71	40	10,0	4
4138581	GTM415044	M9X1.25	6,23	4,91	21,9	71	40	10,0	4
4138583	GTM415045	M10X1.5	7,75	6,11	26,3	76	40	10,0	4
4138585	GTM415046	M11X1.5	7,75	6,11	26,3	76	40	10,0	4
4138597	GTM415047	M12X1.5	9,17	7,21	32,4	86	45	12,0	4

■ **GTM11 and GTM21 • Metric**

													
		Cutting Speed – vc Range – m/min			Feed/Tooth by Diameter			Cutting Speed – vc Range – m/min			Feed/Tooth by Diameter		
Material Group		min	Starting Value	max		<10mm	>10mm	min	Starting Value	max		<10mm	>10mm
		P	1	90	115	150	mm	0,05	0,08	140	185	240	mm
2	90		115	150	mm	0,05	0,08	140	185	240	mm	0,06	0,10
3	40		50	70	mm	0,02	0,03	70	90	120	mm	0,03	0,04
4	–		–	–	–	–	–	70	90	120	mm	0,03	0,04
5	60		80	100	mm	0,04	0,06	70	90	120	mm	0,05	0,08
6	–		–	–	–	–	–	–	–	–	–	–	–
M	1	60	80	100	mm	0,04	0,06	70	90	120	mm	0,05	0,08
	2	60	80	100	mm	0,04	0,06	70	90	120	mm	0,05	0,08
	3	–	–	–	–	–	–	–	–	–	–	–	–
K	1	120	150	200	mm	0,06	0,10	130	170	220	mm	0,06	0,11
	2	120	150	200	mm	0,06	0,10	130	170	220	mm	0,06	0,11
	3	90	115	150	mm	0,05	0,07	110	140	180	mm	0,05	0,07
N	1	200	225	250	mm	0,05	0,06	270	300	330	mm	0,08	0,16
	2	170	190	210	mm	0,04	0,05	160	175	190	mm	0,08	0,16
	3	250	275	300	mm	0,07	0,09	270	300	330	mm	0,08	0,16
	4	250	275	300	mm	0,07	0,09	270	300	330	mm	0,08	0,16
	5	270	300	330	mm	0,12	0,13	250	275	300	mm	0,11	0,20
	6	170	190	210	mm	0,05	0,06	90	100	110	mm	0,11	0,20
S	1	60	80	100	mm	0,04	0,06	70	90	120	mm	0,05	0,08
	2	50	65	80	mm	0,03	0,04	50	60	80	mm	0,03	0,05
	3	50	65	80	mm	0,03	0,04	50	60	80	mm	0,03	0,05
	4	50	65	80	mm	0,03	0,04	50	60	80	mm	0,03	0,05

■ **GTM31 • Metric**

												
		Cutting Speed – vc Range – m/min			Drilling			Milling				
					Recommended Feed by Diameter			Feed/Tooth by Diameter				
Material Group		min	Starting Value	max		<6mm	6–10mm	10–16mm		<6mm	6–10mm	10–16mm
		K	1	130	175	230	mm/r	0,10	0,16	0,30	mm	0,05
N	1	270	300	330	mm/r	0,15	0,25	0,34	mm	0,06	0,08	0,12
	2	140	150	170	mm/r	0,15	0,25	0,34	mm	0,06	0,08	0,12
	4	270	300	330	mm/r	0,15	0,25	0,34	mm	0,06	0,08	0,12
	5	110	120	130	mm/r	0,12	0,20	0,32	mm	0,06	0,08	0,12

NOTE: For thread depths over 2 x D up to 3 x D, reduce speed and feed by 25%.

### ■ Universal Thread Mills • GTM41 • Metric

**Mill • Chamfer • Thread Mill GTM41**

Material Group		TM Style	Grade	Cutting Speed – vc Range – m/min			Feed/Tooth by Diameter		
				min	Starting Value	max		< 10mm	>10mm
P	1	GTM41 R	WU16PV	170	225	290	mm	0,05	0,08
	2	GTM41 R	WU16PV	170	225	290	mm	0,05	0,08
	3	GTM41 R	WU16PV	120	150	200	mm	0,03	0,05
	4	GTM41 R	WU16PV	100	125	160	mm	0,03	0,05
	5	GTM41 R	WU16PV	120	150	200	mm	0,03	0,04
	6	GTM41 R	WU16PV	60	80	100	mm	0,03	0,04
M	1	GTM41 R	WU16PV	120	150	200	mm	0,03	0,04
	2	GTM41 R	WU16PV	120	150	200	mm	0,03	0,04
	3	GTM41 R	WU16PV	120	150	200	mm	0,03	0,04
K	1	GTM41 R	WU16PV	190	250	330	mm	0,06	0,10
	2	GTM41 R	WU16PV	190	250	330	mm	0,06	0,10
	3	GTM41 R	WU16PV	140	185	240	mm	0,04	0,07
N	1	–	–	–	–	–	–	–	–
	2	GTM41 R	WU16PV	180	230	300	mm	0,06	0,07
	3	–	–	–	–	–	–	–	–
	4	GTM41 R	WU16PV	210	275	360	mm	0,06	0,07
	5	–	–	–	–	–	–	–	–
	6	GTM41 R	WU16PV	210	275	360	mm	0,06	0,07
S	1	GTM41 L	WU16PV	120	150	200	mm	0,025	0,045
	2	GTM41 L	WU16PV	50	60	80	mm	0,015	0,025
	3	GTM41 L	WU16PV	50	60	80	mm	0,015	0,025
	4	GTM41 L	WU16PV	70	90	120	mm	0,025	0,035
H	1	GTM41	WU16PV	80	100	130	mm	0,030	0,050
	2	GTM41	WU16PV	80	100	130	mm	0,030	0,050
	3	GTM41	WU16PV	50	65	80	mm	0,020	0,030
	4	GTM41	WU16PV	50	65	80	mm	0,020	0,030

NOTE: For thread depths over 2 x D up to 3 x D, reduce speed and feed by 25%.



# Thread Milling Methods

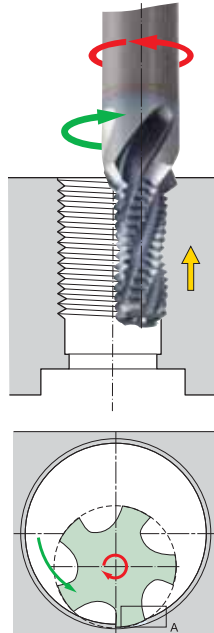
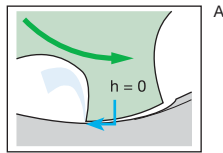
## Climb Milling

**Properties:**

- Tool rotation direction clockwise
- Tool moves anti-clockwise
- Pitch upwards

Right-hand thread

Climb milling is always when the cutting edge goes out of the material with a chip thickness  $h = 0$



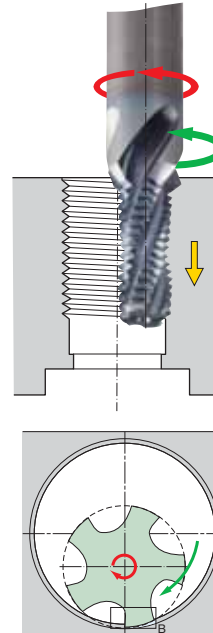
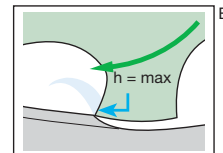
## Conventional Milling

**Properties:**

- Tool rotation direction clockwise
- Tool moves clockwise
- Pitch downwards

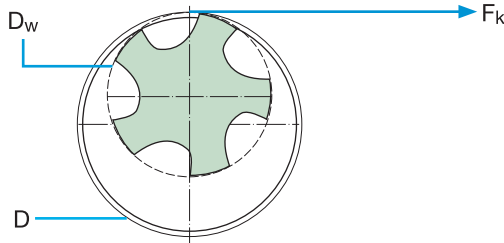
Right-hand thread

Conventional milling is always when the cutting edge goes out of the material with a chip thickness  $h = \text{max}$



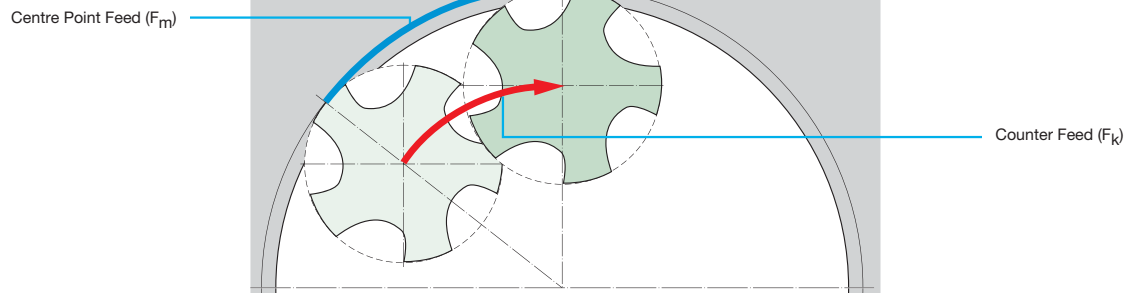
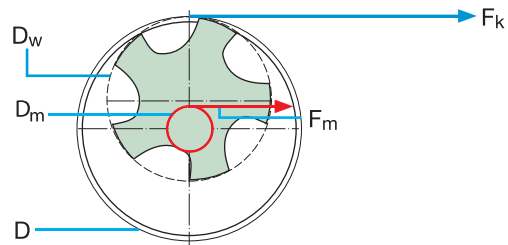
## Counter Feed $F_k$

$$F_k = n \cdot f_z \cdot Z \text{ [mm/min]}$$



## Centre Point Feed $F_m$

$$F_m = \frac{F_k \cdot (D - D_w)}{D} \text{ [mm/min]}$$



- $D_w$  = Tool diameter [mm]
- $n$  = RPM [ $\text{min}^{-1}$ ]
- $f_z$  = Feed per tooth [mm]
- $Z$  = Number of teeth on tool (radial)
- $D$  = Nominal diameter of thread = Diameter of external contour [mm]
- $D_m$  = Diameter of the centre point ( $D - D_w$ ) [mm]

# Thread Mill GTM21

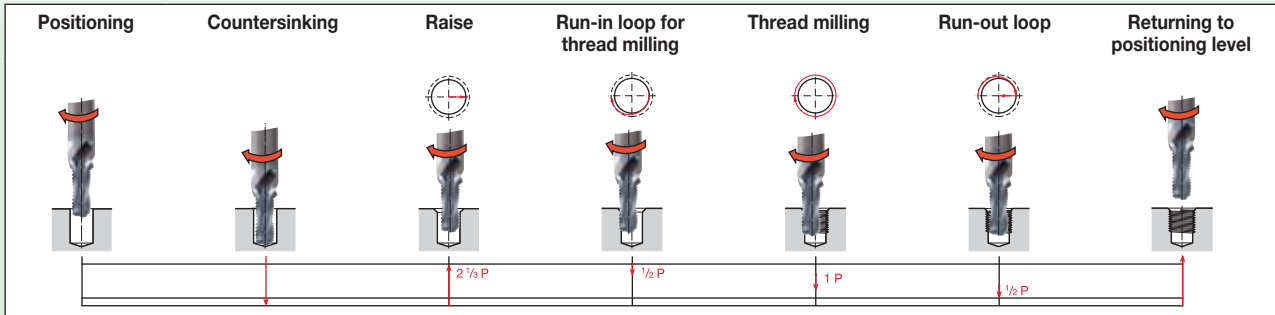
## Preparation

Drilling of thread hole

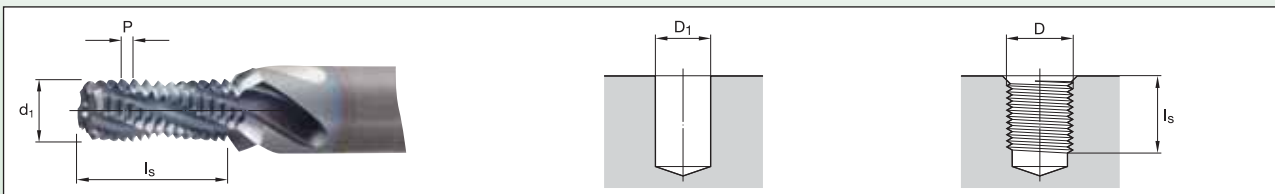
## Process Principle

Countersinking, thread milling (conventional milling)

## Cycle



## Required Specification Values



## Example

<b>Size — M10-6H</b> Thread diameter D ..... 10mm Pitch ..... 1,5mm Core hole diameter D <sub>1</sub> ..... 8,5mm <b>Material — Cast aluminium</b> <b>Grade — WU12PV</b>	<b>Tool — GTM21</b> Catalogue number ..... GTM215004 Number of teeth Z ..... 3 Tool diameter d <sub>1</sub> ..... 8,2mm* Tool radius compensation k <sup>1</sup> ..... 0,1mm** Tool radius to be programmed <sup>2</sup> ..... 4mm*** Countersink depth l <sub>s</sub> ..... 21,2mm Cutting speed v <sub>c</sub> ..... 250 m/min Feed (countersinking) f <sub>s</sub> ..... 0,3 mm/U Feed (milling) f <sub>z</sub> ..... 0,09 mm/tooth	$N = \frac{v_c \cdot 1000}{d_1 \cdot \pi} \quad S = 9709$ $v_s = f_s \cdot n \quad F = 2913 \text{ (countersinking)}$ $v_f = f_z \cdot Z \cdot n \quad F = 2622 \text{ (contour)}$ $v_f = \frac{v_f \text{ contour} \cdot (D - d_1)}{D} \quad F = 472 \text{ (centre point)}$
*(measured on the cutting part)	** (0.01 x D)	*** (1/2 d <sub>1</sub> - k)

## Program to DIN 66025 (conventional milling, on the contour, incremental)

Positioning the tool	N 10	G 54	G 90	G 00	X...	Y...	Z 2	S 9709	T01 <sup>2</sup>	M03
Advancing tool to full thread depth	N 20	G 91	Z-21.200							
Countersinking	N 30	G 01	Z-2	F 2913	(countersink)					
Raise	N 40	G 00	Z 3.450							
Moving sideways to the starting point	N 50	G 42	G01	X 4.250	F 1311	(milling, 1/2 contour)		[F 236] <sup>3</sup>	(milling, 1/2 centre point)	
Run-in loop in arc	N 60	G 02	X-9.25	Y 0.000	Z-0.750	I-4.625	J 0			
Thread milling	N 70	G 02	X 0	Y 0	Z-1.500	I 5	J 0.000	F2622	[F 472] <sup>3</sup>	(centre point)
Run-out loop in arc	N 80	G 02	X 9.25	Y 0.000	Z-0.750	I 4.625	J 0			
Exit	N 90	G 40	G 01	X-4.25						
Retracting tool to positioning level	N 100	G 90	G 00	Z 2						

## Cutting time t<sub>h</sub>

1.4 seconds

### NOTES:

- The cutter radius measured over the tooth crests of the threaded part must be reduced by the amount of the cutter radius compensation. This is necessary to achieve a depth of cut to the middle of the 6H/ISO2 nut tolerance. Please note, however, that this also depends on the radial deflection of the tool (tensile strength of the material, projecting length of the tool).
- The cutter radius to be programmed is normally included in the tool memory.
- The feed values in brackets must be used for controllers, which do not calculate the centre point feed themselves.

## Drill Thread Mill GTM41 • Right Hand

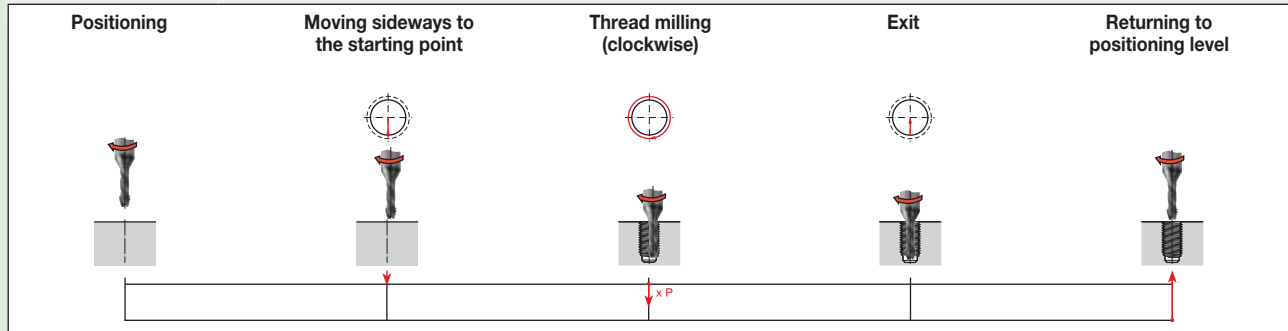
**Preparation**

None

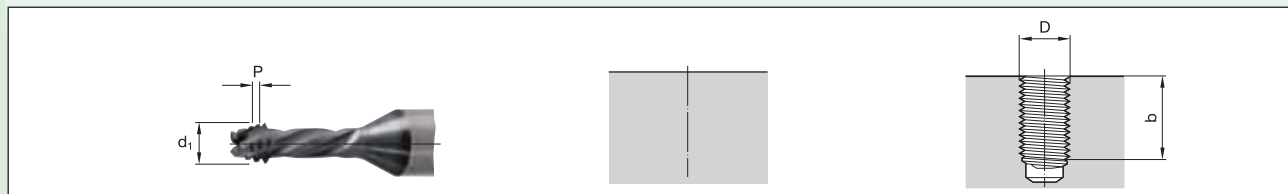
**Process Principle**

Milling thread and core hole, countersinking (conventional milling)

**Cycle**



**Required Specification Values**



**Example**

<p><b>Size — M10-6H</b>          Thread diameter D ..... 10mm          Pitch ..... 1,5mm          Core hole diameter D<sub>1</sub> ..... 8,5mm  <b>Material — Hard steel, 50 HRC</b>  <b>Grade — WU16PV</b></p>	<p><b>Tool — GTM41 Right Hand</b>          Catalogue number ..... GTM415005          Number of teeth Z ..... 4          Tool diameter d<sub>1</sub> ..... 7,75mm*          Tool radius compensation k<sup>1</sup> ..... 0,08mm**          Tool radius to be programmed<sup>2</sup> ..... 3,795mm***          Thread depth b ..... 20mm          Cutting speed v<sub>c</sub> ..... 100 m/min          Feed (milling) f<sub>z</sub> ..... 0,04 mm/tooth          Number of turns<sup>5</sup> ..... 17</p>	$N = \frac{v_c \cdot 1000}{d_1 \cdot \pi} \quad S = 4109$ $v_f = f_z \cdot Z \cdot n \quad F = \frac{657}{(\text{contour})}$ $N = \frac{v_f \text{ contour} \cdot (D - d_1)}{D} \quad F = \frac{148}{(\text{centre point})}$
<p>*(measured on the cutting part)</p>	<p>** (0.01 x D; adjust to application)</p>	<p>*** (1/2 d<sub>1</sub> - k)</p>

**Program to DIN 66025 (conventional milling, on the contour, incremental)**

<b>Positioning the tool</b>	N 10	G 54	G 90	G 00	X...	Y...	Z 1.500	S 4109	T01 <sup>2</sup>	M03 <sup>6</sup>
<b>Incremental programming</b>	N 20	G 91								
<b>Moving sideways to the starting point</b>	N 30	G 42	G 01	X 0	Y -5	F 657 (contour)		[F 148] <sup>4</sup>		(centre point)
<b>Thread milling</b>	N 40	G 02		X 0	Y 0	Z -1.500	I 0	J 5.000		
<b>Repeat thread milling</b>	... 5									
<b>Exit</b>	N 50	G 40	G 01	X 0	Y 5					
<b>Retracting tool to positioning level</b>	N 70	G 90	G 00	Z 2						

**Cutting time t<sub>H</sub>**

51.6 seconds

**NOTES:**

- The cutter radius measured over the tooth crests of the threaded part must be reduced by the amount of the cutter radius compensation. This is necessary to achieve a depth of cut to the middle of the 6H/ISO2 nut tolerance. Please note, however, that this also depends on the radial deflection of the tool (tensile strength of the material, projecting length of the tool).
- The cutter radius to be programmed is normally included in the tool memory.
- The thread depth b must be divisible by the thread pitch P.
- The feed values in brackets must be used for controllers, which do not calculate the centre point feed themselves.
- Set N40 must be repeated with the number of threads. Repetitions N = thread depth b/pitch P (rounded up to the nearest integer).

## Drill Thread Mill GTM41 • Left Hand

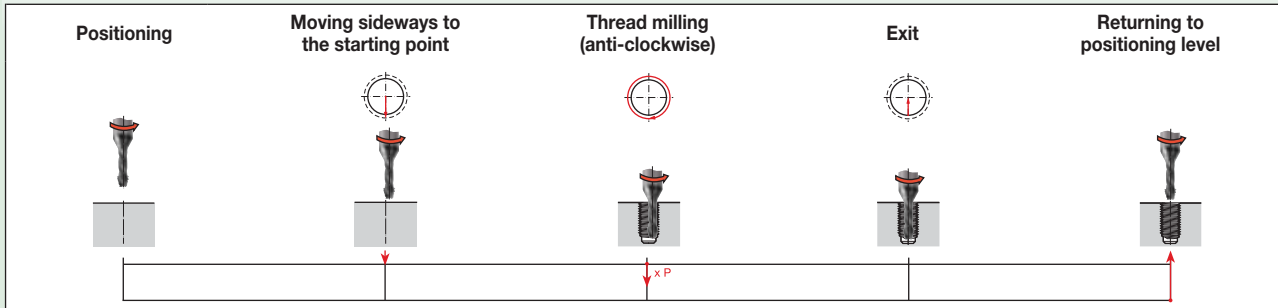
### Preparation

None

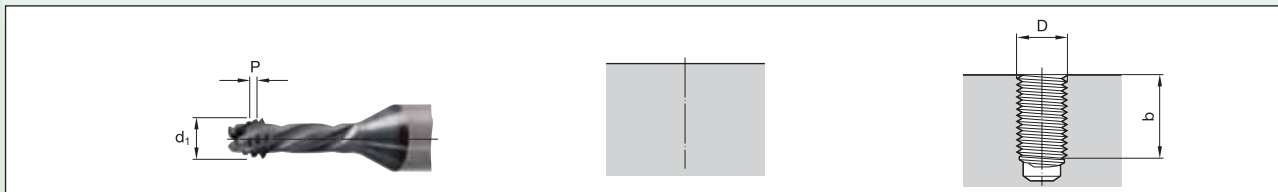
### Process Principle

Milling thread and core hole, countersinking (climb milling)

### Cycle



### Required Specification Values



### Example

<b>Size — M10-6H</b> Thread diameter $D$ ..... 10mm Pitch ..... 1,5mm Core hole diameter $D_1$ ..... 8,5mm <b>Material — TiAl6V4 titanium</b> <b>Grade — WU16PV</b>	<b>Tool — GTM41 Left Hand</b> Catalogue number ..... GTM415005 Number of teeth $Z$ ..... 4 Tool diameter $d_1$ ..... 7,75mm* Tool radius compensation $k^1$ ..... 0,08mm** Tool radius to be programmed <sup>2</sup> ..... 3,795mm*** Thread depth $b$ ..... 20mm Cutting speed $v_c$ ..... 100 m/min Feed (milling) $f_z$ ..... 0,03 mm/tooth Number of turns <sup>5</sup> ..... 17	$N = \frac{v_c \cdot 1000}{d_1 \cdot \pi} \quad S = 4109$ $v_f = f_z \cdot Z \cdot n \quad F = \frac{493}{(\text{contour})}$ $N = \frac{v_f \text{ contour} \cdot (D - d_1)}{D} \quad F = 111 \quad (\text{centre point})$
*(measured on the cutting part)	**(0.01 x D)	***( $1/2 d_1 - k$ )

### Program to DIN 66025 (climb milling, on the contour, incremental)

Positioning the tool	N 10	G 54	G 90	G 00	X...	Y...	Z 1.500	S 4109	T01 <sup>2</sup>	M04
Incremental programming	N 20	G 91								
Moving sideways to the starting point	N 30	G 42	G 01	X 0	Y-5	F 493 (contour)	[F 111] <sup>4</sup>			(centre point)
Thread milling	N 40	G 02		X 0	Y 0	Z-1.500	I 0	J 5.000		
Repeat thread milling	...	5								
Exit	N 50	G 40	G 01	X 0	Y 5					
Retracting tool to positioning level	N 70	G 90	G 00	Z 2						

### Cutting time $t_H$

68.8 seconds

#### NOTES:

- The cutter radius measured over the tooth crests of the threaded part must be reduced by the amount of the cutter radius compensation. This is necessary to achieve a depth of cut to the middle of the 6H/ISO2 nut tolerance. Please note, however, that this also depends on the radial deflection of the tool (tensile strength of the material, projecting length of the tool).
- The cutter radius to be programmed is normally included in the tool memory.
- The thread depth  $b$  must be divisible by the thread pitch  $P$ .
- The feed values in brackets must be used for controllers, which do not calculate the centre point feed themselves.
- Set N40 must be repeated with the number of threads. Repetitions  $N = \text{thread depth } b / \text{pitch } P$  (rounded up to the nearest integer).

# Drill Thread Mill GTM31

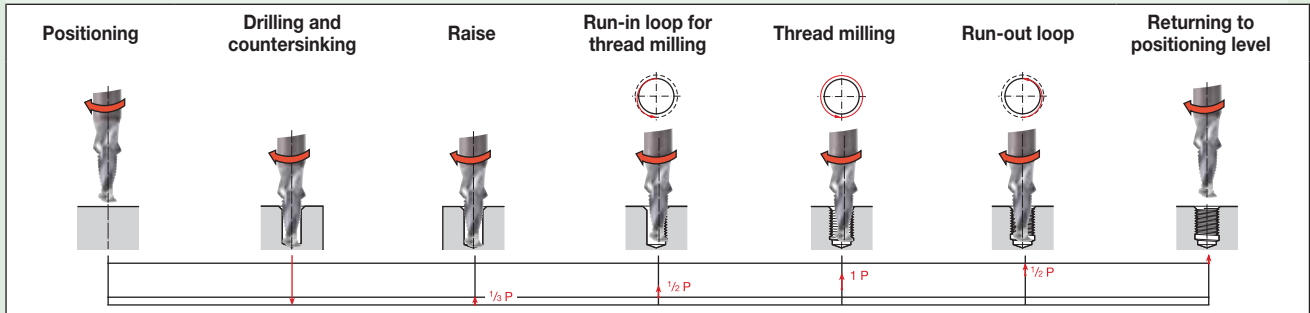
**Preparation**

Drilling of thread hole

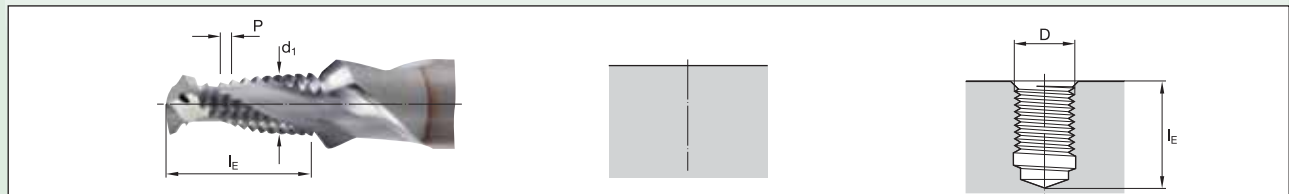
**Process Principle**

Drilling, countersinking, thread milling (climb milling)

**Cycle**



**Required Specification Values**



**Example**

<p><b>Size — M10-6H</b></p> <p>Thread diameter D ..... 10mm</p> <p>Pitch ..... 1,5mm</p> <p>Core hole diameter D<sub>1</sub> ..... 8,5mm</p> <p><b>Material — Grey cast iron</b></p> <p><b>Grade — WU12PV</b></p>	<p><b>Tool — GTM31</b></p> <p>Catalogue number ..... GTM315005</p> <p>Number of teeth Z ..... 2</p> <p>Tool diameter d<sub>1</sub> ..... 8,2mm*</p> <p>Tool radius compensation k<sup>1</sup> ..... 0,1mm**</p> <p>Tool radius to be programmed<sup>2</sup> ..... 4mm***</p> <p>Countersink depth l<sub>S</sub> ..... 19,11mm</p> <p>Cutting speed v<sub>C</sub> ..... 250 m/min</p> <p>Feed (countersinking) f<sub>S</sub> ..... 0,25 mm/U</p> <p>Feed (milling) f<sub>Z</sub> ..... 0,1 mm/tooth</p>	$N = \frac{v_c \cdot 1000}{d_1 \cdot \pi} \quad S = 9709$ $v_s = f_b \cdot n \quad F = 2427 \text{ (drilling, countersinking)}$ $v_f = f_z \cdot Z \cdot n \quad F = 1942 \text{ (contour)}$ $v_f = \frac{v_f \text{ contour} \cdot (D - d_1)}{D} \quad F = 350 \text{ (centre point)}$
<p>*(measured on the cutting part)</p>	<p>** (0.01 x D)</p>	<p>*** (1/2 d<sub>1</sub> - k)</p>

**Program to DIN 66025 (climb milling, on the contour, incremental)**

<b>Positioning the tool</b>	N 10	G 54	G 90	G 00	X...	Y...	Z 2	S 9709	T01 <sup>2</sup>	M03
<b>Drilling and countersinking</b>	N 20	G 91	G 01	Z-21.110	F 2427	(drill, countersink)				
<b>Raise</b>	N 30	G 01	Z 0.500							
<b>Moving sideways to the starting point</b>	N 40	G 41	Y-4.250	F 971	(milling, 1/2 contour)		[F 175] <sup>3</sup>	(1/2 centre point)		
<b>Run-in loop in arc</b>	N 50	G 03	X 0	Y 9.250	Z 0.750	I 0	J 4.625			
<b>Thread milling</b>	N 60	G 03	X 0	Y 0	Z 1.500	I 0	J -5.000			
<b>Run-out loop in arc</b>	N 70	G 03	X 0	Y-9.250	Z 0.750	I 0	J- 4.625	F1942	[F 350] <sup>3</sup>	(centre point)
<b>Exit</b>	N 80	G 00	G 40	X 0	Y 4.250					
<b>Retracting tool to positioning level</b>	N 90	G 90	Z 2							



**Cutting time t<sub>h</sub>**

2.3 seconds



**NOTES:**

- The cutter radius measured over the tooth crests of the threaded part must be reduced by the amount of the cutter radius compensation. This is necessary to achieve a depth of cut to the middle of the 6H/ISO2 nut tolerance. Please note, however, that this also depends on the radial deflection of the tool (tensile strength of the material, projecting length of the tool).
- The cutter radius to be programmed is normally included in the tool memory.
- The feed values in brackets must be used for controllers, which do not calculate the centre point feed themselves.

### ■ Carbide Taps • Metric

Material Group	 Through Holes						 Blind Holes				
	Tap Style	Grade	Range – m/min			Tap Style	Grade	Range – m/min			
			min	Starting Value	max			min	Starting Value	max	
<b>P</b>	P0	GX32, GX38	GP4535	60	100	130	GX33, GX39	GP4535	50	70	90
	P1	GX32, GX38	GP4535	60	90	120	GX33, GX39	GP4535	40	60	80
	P2	GX32, GX38	GP4535	50	85	110	GX33, GX39	GP4535	40	60	80
	P3	GX32, GX38	GP4535	50	80	100	GX33, GX39	GP4535	40	60	80
<b>K</b>	K1	GX34, GX50	WK12PG	70	105	140	GX35, GX50	WK12PG	50	70	90
	K2	GX34, GX50	WK12PG	60	100	130	GX35, GX50	WK12PG	50	70	90
	K3	GX34, GX50	WK12PG	60	90	120	GX35, GX50	WK12PG	40	60	80
<b>N</b>	N2	GX46, GX48	WN14PG	80	120	160	GX47, GX49	WN14PG	60	80	100
	N3	GX46, GX48	WN14PG	60	100	130	GX47, GX49	WN14PG	50	70	90
	N4	GX46, GX48	WN14PG	60	90	120	GX47, GX49	WN14PG	40	60	80
<b>H</b>	H3	GX10	WH16PG	1,2	1,5	2,0	GX10	WH16PG	0,8	1,1	1,4
	H4	GX10	WH16PG	0,6	0,8	1,0	GX10	WH16PG	0,4	0,5	0,7

■ HSS-E-PM Taps • Metric

Material Group		 Through Holes					 Blind Holes				
				Range – m/min					Range – m/min		
		Tap Style	Grade	min	Starting Value	max	Tap Style	Grade	min	Starting Value	max
P	P1	GT20	GP6520	20	30	45	GT30, GT32, GT50	GP6520	14	21	32
		GT24	WU32MG	20	30	45	GT24, GT26	WU32MG	14	21	32
	P2	GT20	GP6520	17	25	38	GT30, GT32, GT50	GP6520	12	18	26
		GT24	WU32MG	17	25	38	GT24, GT26	WU32MG	12	18	26
	P3	GT20	GP6520	12	15	20	GT30, GT32, GT50	GP6520	8	11	14
	P4	GT00	WP31MG	5	6	8	GT02, GT04	WP31MG	3	4	5
	P5	GT20	GP6520	12	15	20	GT30, GT32, GT50	GP6520	8	11	14
P6	GT00	WP31MG	6	8	10	GT02, GT04	WP31MG	4	6	7	
M	M1	GT20	GM6515	12	15	20	GT30, GT32, GT50	GM6515	8	11	14
		GT24	WU32MG	5	8	12	GT24, GT26	WU32MG	4	6	8
	M2	GT20	GM6515	9	12	16	GT30, GT32, GT50	GM6515	6	8	11
K	M3	GT00	WP31MG	4	5	7	GT02, GT04	WP31MG	3	4	5
		K1	GT40	GP6520	27	35	46	GT40, GT42	GP6520	19	25
N	K2	GT40	GP6520	23	30	39	GT40, GT42	GP6520	16	21	27
		N1	GT72	WN44EG	33	50	65	GT82, GT86	WN44EG	23	35
	N2	GT22	WN48EG	37	55	72	GT22	WN48EG	26	39	50
		GT40	GP6520	30	45	59	GT40, GT42	GP6520	21	32	41
	N4	GT72	WN44EG	30	45	59	GT82, GT86	WN44EG	21	32	41
		GT22	WN38MG	33	50	65	GT22	WN38MG	23	35	46
S	S1	GT40	GP6520	7	10	15	GT40, GT42	GP6520	5	7	11
	S2, S3	GT20	GP6520	8	12	18	GT30, GT32	GP6520	6	8	13
		GT90	WU32MG	3,3	5,0	7,5	GT92, GT94	WU32MG	2,3	3,5	5,3
	S4	GT90	WS39MG	1,7	2,5	3,8	GT92, GT94	WS39MG	1,2	1,8	2,6
		GT60	WS34MG	2,7	4,0	6,0	GT62	WS34MG	1,9	2,8	4,2
H	H1	GT60	WS30MG	1,3	2,0	3,0	GT62	WS30MG	0,9	1,4	2,1
		H2	GT06	WN35MG	1,3	2,0	3,0	GT06	WN35MG	0,9	1,4
		GT06	WN35MG	1,0	1,5	2,3	GT06	WN35MG	0,7	1,1	1,6

NOTE: Increase speed by up to 25% when using coolant taps (GT21, GT23, GT31, GT33, GT41, GT43, and GT51). Use grade GP6505™ in steels. Use 50% of the recommended speed listed for grade GP6520™.

■ VariTap • HSS-E • Metric

Material Group		 Through Holes					 Blind Holes				
		Tap Style	Grade	Range – m/min			Tap Style	Grade	Range – m/min		
				min	Starting Value	max			min	Starting Value	max
P	P1	VT-SPO	WP42EG, WU41EG	21	27	34	VT-SFT	WP42EG, WU41EG	13	18	26
		VT-SPO	WP49EG, WU40EG	10	14	17	VT-SFT	WP49EG, WU40EG	6	9	13
	P2	VT-SPO	WP42EG, WU41EG	16	21	27	VT-SFT	WP42EG, WU41EG	11	15	22
		VT-SPO	WP49EG, WU40EG	8	11	13	VT-SFT	WP49EG, WU40EG	4	6	9
	P3	VT-SPO	WP42EG, WU41EG	9	12	15	VT-SFT	WP42EG, WU41EG	6	9	13
		VT-SPO	WP49EG, WU40EG	5	6	8	VT-SFT	WP49EG, WU40EG	2	3	4
		VT-STR NPT	WU41EG	5	6	8	VT-STR NPT	WU41EG	5	6	8
		VT-STR NPT	WU40EG	2	3	4	VT-STR NPT	WU40EG	2	3	4
M	M1	VT-SPO	WP42EG, WU41EG	9	12	15	VT-SFT	WP42EG, WU41EG	6	9	13
		VT-SPO	WP49EG, WU40EG	5	6	8	VT-SFT	WP49EG, WU40EG	2	3	4
		VT-SFT NPT	WU41EG	5	6	8	VT-SFT NPT	WU41EG	5	6	8
		VT-SFT NPT	WP49EG, WU40EG	2	3	4	VT-SFT NPT	WP49EG, WU40EG	2	3	4
	M3	VT-SPO	WP42EG, WU41EG	7	9	11	VT-SFT	WP42EG, WU41EG	4	6	9
VT-SPO		WP49EG, WU40EG	3	5	6	VT-SFT	WP49EG, WU40EG	2	3	4	
K	K1	VT-STR NPT	WU41EG	10	14	17	VT-STR NPT	WU41EG	10	14	17
		VT-STR NPT	WU40EG	6	8	10	VT-STR NPT	WU40EG	6	8	10
	K2	VT-SPO	WP42EG, WU41EG	21	27	34	VT-SFT	WP42EG, WU41EG	13	18	26
VT-SPO		WP49EG, WU40EG	10	14	17	VT-SFT	WP49EG, WU40EG	6	9	13	
N	N1	VT-SPO	WP42EG, WU41EG	34	46	57	VT-SFT	WP42EG, WU41EG	23	34	48
		VT-SPO	WU40EG	17	23	29	VT-SFT	WU40EG	11	15	22
	N2	VT-SPO	WP42EG, WU41EG	30	40	50	VT-SFT	WP42EG, WU41EG	19	27	39
		VT-SPO	WU40EG	15	20	25	VT-SFT	WU40EG	11	15	22
	N4	VT-SPO	WP42EG, WU41EG	7	9	11	VT-SFT	WP42EG, WU41EG	4	6	9
		VT-SPO	WU40EG	3	5	6	VT-SFT	WU40EG	2	3	4

\* Grades: WP42EG = TiCN  
 WU41EG = TiN  
 WP49EG = oxide  
 WU40EG = bright



# Reconditioning Services

## Anyone can regrind our tools – but only we can recondition them

WIDIA™ Reconditioning Services optimise the value of metalcutting tools throughout their entire lifecycle by giving like-new performance — with rapid turnaround time — so tools are always on hand and perform just like new.

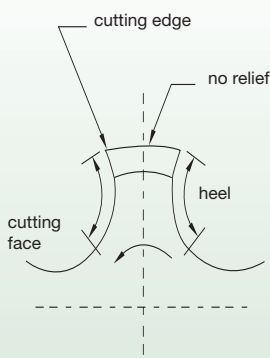
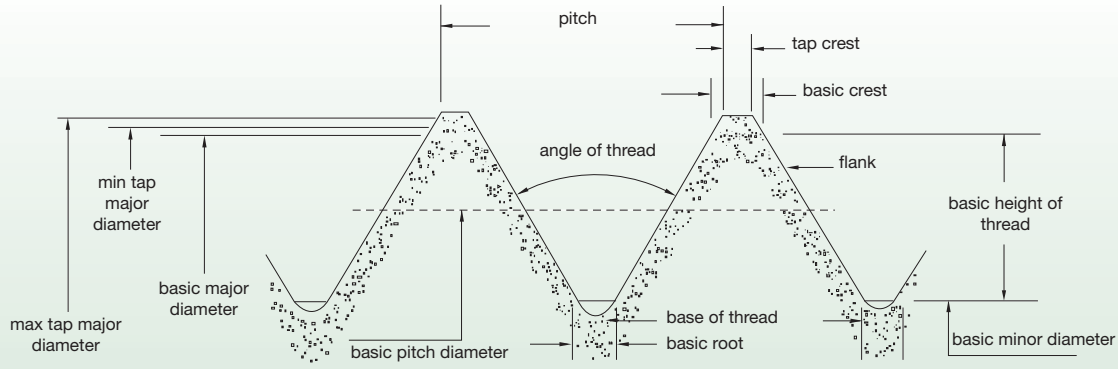
To use WIDIA tool reconditioning services, contact your authorised WIDIA distributor to get started.

### Global Reconditioning Network

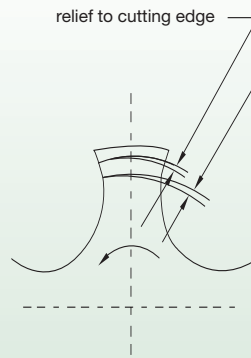


To locate a Reconditioning Center near you, visit [widia.com/services](http://widia.com/services).

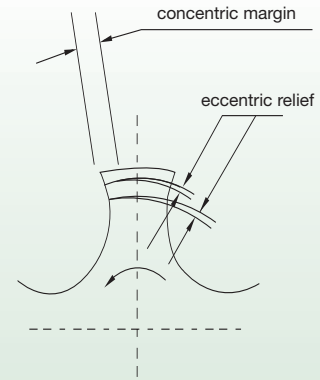




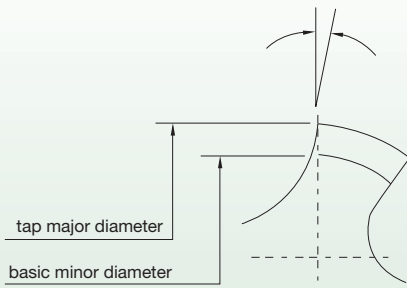
**Concentric**



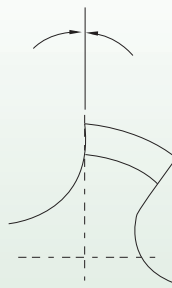
**Eccentric Relief**



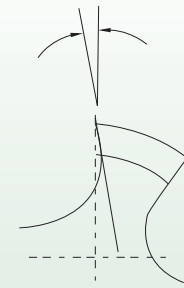
**Con-Eccentric Relief**



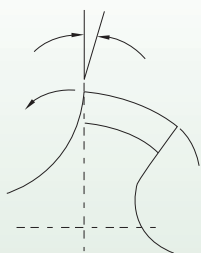
**Negative Hook**



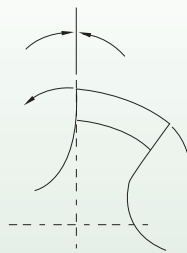
**0° Hook**



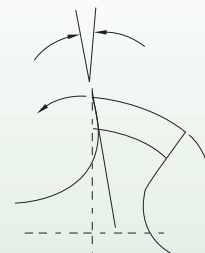
**Positive Hook**



**Negative Rake**



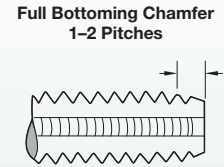
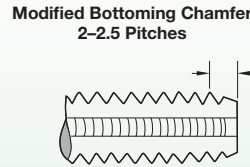
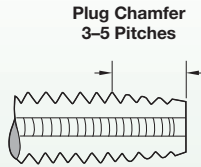
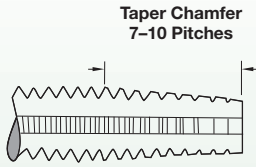
**Radial Rake**



**Positive Rake**

Reprinted with permission from United States Cutting Tool Institute (USCTI). Published by Kennametal Inc. © 2014. All rights reserved.

■ Tap Chamfers • ANSI Taps



**Tap Chamfers**

**Taper** (7–10 pitches)

The taper chamfer has the longest standard chamfer ensuring easier starting. It requires less tapping torque because of more working teeth.

**Plug** (3–5 pitches)

The most common chamfer for use by hand or machine in through or blind holes. This chamfer is more efficient than a bottoming or modified bottoming chamfer.

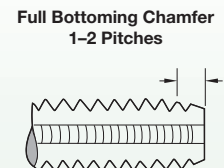
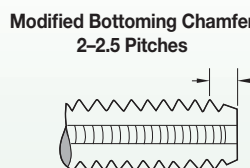
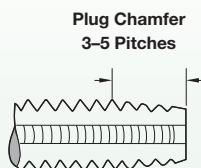
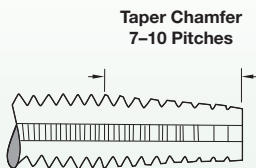
**Semi-Bottom** (2–2.5 pitches)

This short chamfer enables threading close to the bottom of blind holes. Due to the slightly longer chamfer and more working teeth, this chamfer is more efficient than a bottoming chamfer.

**Bottoming** (1–2 pitches)

For threading close to the bottom of blind holes, the bottoming chamfer is the least efficient chamfer available.

■ Tap Chamfers • DIN Taps



**Hand Tap Chamfers**

**Form A** (6–8 pitches)

The Form A chamfer has the longest standard chamfer ensuring easier starting. It requires less tapping torque because of more working teeth.

**Form B/D** (3.5–5 pitches)

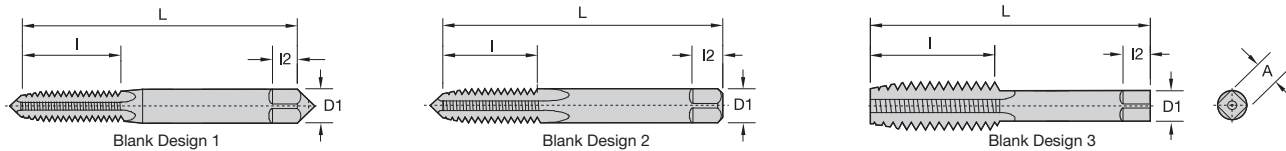
The most common chamfers for use by hand or machine in through or blind holes. Form B applies to spiral-point taps and Form D applies to straight-flute and spiral-flute taps. This chamfer is more efficient than Form E or Form C chamfer.

**Form C** (2–2.5 pitches)

This short chamfer enables threading close to the bottom of blind holes. Due to the slightly longer chamfer and more working teeth, this chamfer is more efficient than a Form E chamfer.

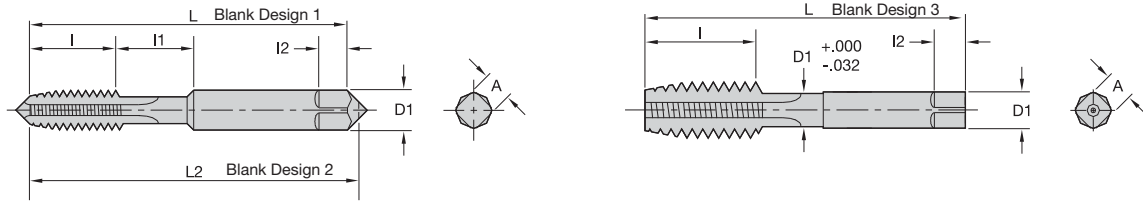
**Form E** (1.5–2 pitches)

For threading close to the bottom of blind holes, the Form E chamfer is the least efficient chamfer available.



nominal diameter range (in)	machine screw size number (in)	nominal fractional diameter (in)	nominal metric diameter mm (in)	blank design number	overall length L	thread length l	square length l2	shank diameter D1	square size A
.052-.065	0 (.0600)	—	M1.6 (.0630)	1	1.63	.31	.19	.1410	.110
.065-.078	1 (.0730)	—	M1.8 (.0709)	1	1.69	.38	.19	.1410	.110
.078-.091	2 (.0860)	—	M2 (0.787), M2.2 (.0866)	1	1.75	.44	.19	.1410	.110
.091-.104	3 (.0990)	—	M2.5 (.0984)	1	1.81	.50	.19	.1410	.110
.104-.117	4 (.1120)	—	—	1	1.88	.56	.19	.1410	.110
.117-.130	5 (.1250)	—	M3 (.1181)	1	1.94	.63	.19	.1410	.110
.130-.145	6 (.1380)	—	M3.5 (.1378)	1	2.00	.69	.19	.1410	.110
.145-.171	8 (.1640)	—	M4 (.1575)	1	2.13	.75	.25	.1680	.131
.171-.197	10 (.1900)	—	M4.5 (.1772), M5 (.1969)	1	2.38	.88	.25	.1940	.152
.197-.223	12 (.2160)	—	—	1	2.38	.94	.28	.2200	.165
.223-.260	—	1/4 (.2500)	M6 (.2362)	2	2.50	1.00	.31	.2550	.191
.260-.323	—	5/16 (.3125)	M7 (.2756), M8 (.3150)	2	2.72	1.13	.38	.3180	.238
.323-.395	—	3/8 (.3750)	M10 (.3937)	2	2.94	1.25	.44	.3810	.286
.395-.448	—	7/16 (.4375)	—	3	3.16	1.44	.41	.3230	.242
.448-.510	—	1/2 (.5000)	M12 (.4724)	3	3.38	1.66	.44	.3670	.275
.510-.573	—	9/16 (.5625)	M14 (.5512)	3	3.59	1.66	.50	.4290	.322
.573-.635	—	5/8 (.6250)	M16 (.6299)	3	3.81	1.81	.56	.4800	.360
.635-.709	—	11/16 (.6875)	M18 (.7087)	3	4.03	1.81	.63	.5420	.406
.709-.760	—	3/4 (.7500)	—	3	4.25	2.00	.69	.5900	.442
.760-.823	—	13/16 (.8125)	M20 (.7874)	3	4.47	2.00	.69	.6520	.489
.823-.885	—	7/8 (.8750)	M22 (.8661)	3	4.69	2.22	.75	.6970	.523
.885-.948	—	15/16 (.9375)	M24 (.9449)	3	4.91	2.22	.75	.7600	.570
.948-1.010	—	1 (1.0000)	M25 (.9843)	3	5.13	2.50	.81	.8000	.600
1.010-1.073	—	1-1/16 (1.0625)	M27 (1.0630)	3	5.13	2.50	.88	.8960	.672
1.073-1.135	—	1-1/8 (1.1250)	—	3	5.44	2.56	.88	.8960	.672
1.135-1.198	—	1-3/16 (1.1875)	M30 (1.1811)	3	5.44	2.56	1.00	1.0210	.766
1.198-1.260	—	1-1/4 (1.2500)	—	3	5.75	2.56	1.00	1.0210	.766
1.260-1.323	—	1-5/16 (1.3125)	M33 (1.2992)	3	5.75	2.56	1.06	1.1080	.831
1.323-1.385	—	1-3/8 (1.3750)	—	3	6.06	3.00	1.06	1.1080	.831
1.358-1.448	—	1-7/16 (1.4375)	M36 (1.4173)	3	6.06	3.00	1.13	1.2330	.925
1.448-1.510	—	1-1/2 (1.5000)	—	3	6.38	3.00	1.13	1.2330	.925
1.510-1.635	—	1-5/8 (1.6250)	M39 (1.5354)	3	6.69	3.19	1.13	1.3050	.979
1.635-1.760	—	1-3/4 (1.7500)	M42 (1.6535)	3	7.00	3.19	1.25	1.4300	1.072
1.760-1.885	—	1-7/8 (1.8750)	—	3	7.31	3.56	1.25	1.5190	1.139
1.885-2.010	—	2 (2.0000)	M48 (1.8898)	3	7.63	3.56	1.38	1.6440	1.233
2.010-2.135	—	2-1/8 (2.1250)	—	3	8.00	3.56	1.38	1.7690	1.327
2.135-2.260	—	2-1/4 (2.2500)	M56 (2.2047)	3	8.25	3.56	1.44	1.8940	1.420
2.260-2.385	—	2-3/8 (2.3750)	—	3	8.50	4.00	1.44	2.0190	1.514
2.385-2.510	—	2-1/2 (2.5000)	—	3	8.75	4.00	1.50	2.1000	1.575
2.510-2.635	—	2-5/8 (2.6250)	M64 (2.5197)	3	8.75	4.00	1.50	2.2250	1.669
2.635-2.760	—	2-3/4 (2.7500)	—	3	9.25	4.00	1.56	2.3500	1.762
2.760-2.885	—	2-7/8 (2.8750)	M72 (2.8346)	3	9.25	4.00	1.56	2.4750	1.856
2.885-3.010	—	3 (3.0000)	—	3	9.75	4.56	1.63	2.5430	1.907
3.010-3.135	—	3-1/8 (3.1250)	—	3	9.75	4.56	1.63	2.6680	2.001
3.135-3.260	—	3-1/4 (3.2500)	M80 (3.1496)	3	10.00	4.56	1.75	2.7930	2.095
3.260-3.385	—	3-3/8 (3.3750)	—	3	10.00	4.56	1.75	2.8830	2.162
3.385-3.510	—	3-1/2 (3.5000)	—	3	10.25	4.94	2.00	3.0080	2.256
3.510-3.635	—	3-5/8 (3.6250)	M90 (3.5433)	3	10.25	4.94	2.00	3.1330	2.350
3.635-3.760	—	3-3/4 (3.7500)	—	3	10.50	5.31	2.13	3.2170	2.413
3.760-3.885	—	3-7/8 (3.8750)	—	3	10.50	5.31	2.13	3.3420	2.506
3.885-4.010	—	4 (4.0000)	M100 (3.9370)	3	10.75	5.31	2.25	3.4670	2.600

Reprinted with permission from United States Cutting Tool Institute (USCTI). Published by Kennametal Inc. © 2014. All rights reserved.



■ General Dimensions

Tap Dimensions – Inches

nominal diameter range (in)	machine screw size number (in)	nominal fractional diameter (in)	nominal metric diameter mm (in)	blank design number	Tap Dimensions – Inches					
					overall length L	thread length l	neck length l1	square length l2	shank diameter D1	square size A
.104 .117	4 (.1120)	—	—	1	1.88	.31	.25	.19	.1410	.110
.117 .130	5 (.1250)	—	M3 (.1181)	1	1.94	.31	.31	.19	.1410	.110
.130 .145	6 (.1380)	—	M3.5 (.1378)	1	2.00	.38	.31	.19	.1410	.110
.145 .171	8 (.1640)	—	M4 (.1575)	1	2.13	.38	.38	.25	.1680	.131
.171 .197	10 (.1900)	—	M4.5 (.1772)	1	2.38	.50	.38	.25	.1940	.152
			M5 (.1969)	—	—	—	—	—	—	—
.197 .223	12 (.2160)	—	—	1	2.38	.50	.44	.28	.2200	.165
.223 .260	—	1/4 (.2500)	M6 (.2362)	2	2.50	.63	.38	.31	.2550	.191
.260 .323	—	5/16 (.3125)	M7, M8 (.2756), (.3150)	2	2.72	.69	.44	.38	.3180	.238
.323 .395	—	3/8 (.3750)	M10 (.3937)	2	2.94	.75	.50	.44	.3810	.286
.395 .448	—	7/16 (.4375)	—	3	3.16	.88	—	.41	.3230	.242
.448 .510	—	1/2 (.5000)	M12 (.4724)	3	3.38	.94	—	.44	.3670	.275
.510 .573	—	9/16 (.5625)	M14 (.5541)	3	3.59	1.00	—	.50	.4290	.322
.573 .635	—	5/8 (.6250)	M16 (.6299)	3	3.81	1.09	—	.56	.4800	.360
.635 .709	—	11/16 (.6875)	M18 (.7087)	3	4.03	1.09	—	.63	.5420	.406
.709 .760	—	3/4 (.7500)	—	3	4.25	1.22	—	.69	.5900	.442
.760 .823	—	13/16 (.8125)	M20 (.7874)	3	4.47	1.22	—	.69	.6520	.489
.823 .885	—	7/8 (.8750)	M22 (.8661)	3	4.69	1.34	—	.75	.3670	.523
.885 .948	—	15/16 (.9375)	M24 (.9449)	3	4.91	1.34	—	.75	.7600	.570
.948 1.010	—	1 (1.0000)	M25 (.9843)	3	5.13	1.50	—	.81	.8000	.600

Reprinted with permission from United States Cutting Tool Institute (USCTI). Published by Kennametal Inc. © 2014. All rights reserved.

NOTE: Thread length l is based on a length of 12 pitches of the UNC thread series. Thread length "l" is a minimum value and has no tolerance. When thread length "l" is added to neck length "l1", the total shall be no less than the minimum USCTI Table 302 thread length "l". Unless otherwise specified, all tolerances are in accordance with USCTI Table 302. For eccentricity tolerances, see USCTI Table 317. Table 302 is provided for reference only. WIDIA-GTD™ tap dimensions may differ.

■ Tolerances

element	nominal diameter range (in)	direction	tolerance (in)
length overall — L	.0520–1.0100	plus or minus	.031
	1.0100–4.0100	plus or minus	.063
length of thread — l	.0520–.2230	plus or minus	.047
	.2230–.5100	plus or minus	.063
	.5100–1.5100	plus or minus	.094
	1.5100–4.0100	plus or minus	.125
length of square — l2	.0520–1.0100	plus or minus	.031
	1.0100–4.0100	plus or minus	.063
diameter of shank — d1	.0520–.2230	minus	.0015
	.2230–.6350	minus	.0015
	.6350–1.0100	minus	.0020
	1.0100–1.5100	minus	.0020
	1.5100–2.0100	minus	.0030
	2.0100–4.0100	minus	.0030
size of square — a	.0520–.5100	minus	.004
	.5100–1.0100	minus	.006
	1.0100–2.0100	minus	.008
	2.0100–4.0100	minus	.010

Reprinted with permission from United States Cutting Tool Institute (USCTI). Published by Kennametal Inc. © 2014. All rights reserved.

■ Special Taps

Unless otherwise specified:

Special taps over 1.010–1.510" diameter inclusive, having 14 or more threads per inch or 1,75mm pitch and finer, and sizes over 1.510" diameter with 10 or more threads per inch or 2,5mm pitch and finer, are made to general dimensions shown in USCTI Table 303.

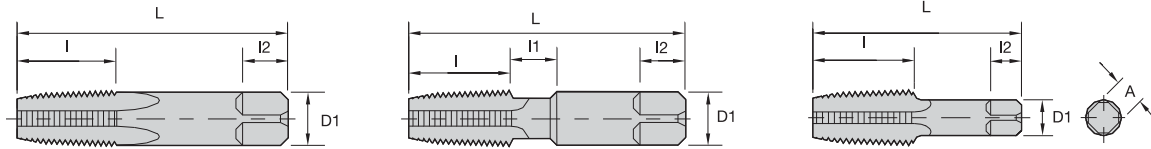
Special tap thread limits are determined using the formulas shown in USCTI Table 331 for Unified Inch Screw Threads and USCTI Table 341 for metric m-profile screw threads.

NOTE:

Tap sizes .395" and smaller have an external centre on the thread end (may be removed on bottoming taps). Sizes .125" and smaller have an external centre on the shank end. Sizes .224–.395" have truncated partial cone centres on the shank end (length of cone approximately 1/4 of diameter of shank). Sizes over .395" have internal centres on both the thread and shank ends.

For standard thread limits and tolerances for Unified Inch Screw Threads, see USCTI Table 327, and for metric threads, see USCTI Table 337.

For eccentricity tolerances of tap elements, see USCTI Table 317.



■ General Dimensions

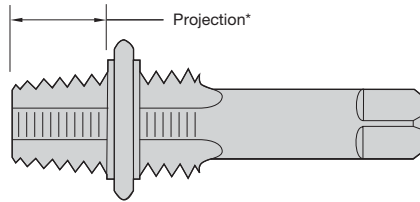
nominal size (in)	dimensions (in)					
	overall length L	thread length l	square length l2	shank diameter D1	square size A	optional neck length l1
1/16	2.13	.69	.38	.3125	.234	.375
1/8	2.13	.75	.38	.3125	.234	–
1/8	2.13	.75	.38	.4375	.328	.375
1/4	2.44	1.06	.44	.5625	.421	.375
3/8	2.56	1.06	.50	.7000	.531	.375
1/2	3.13	1.38	.63	.6875	.515	–
3/4	3.25	1.38	.69	.9063	.679	–
1	3.75	1.75	.81	1.1250	.843	–
1-1/4	4.00	1.75	.94	1.3125	.984	–
1-1/2	4.25	1.75	1.00	1.5000	1.125	–
2	4.25	1.75	1.13	1.8750	1.406	–
2-1/2	5.50	2.56	1.25	2.2500	1.687	–
3	6.00	2.63	1.38	2.6250	1.968	–
3-1/2	6.50	2.69	1.50	2.8125	2.108	–
4	6.75	2.75	1.56	3.0000	2.250	–

Reprinted with permission from United States Cutting Tool Institute (USCTI).  
Published by Kennametal Inc. © 2014. All rights reserved.

■ Tolerances

element	range	direction	tolerance
length overall – L	1/16–3/4 inc.	plus/minus	.031
	1–4 inc.	plus/minus	.063
length of thread – l	1/16–3/4 inc.	plus/minus	.063
	1–1-1/4 inc.	plus/minus	.094
length of square – l2	1–1-2–4	plus/minus	.125
	1/16–3/4 inc.	plus/minus	.031
diameter of shank – d1	1–4 inc.	plus/minus	.063
	1/16–1/8	minus	.0015
size of square – a	1/4–1 inc.	minus	.0020
	1–1/4–4 inc.	minus	.0030
	1/16–1/8	minus	.004
	1/4–3/4 inc.	minus	.006
	1–4 inc.	minus	.008

American National Standard Taper Pipe Thread Form (NPT)  
Aeronautical National Taper Pipe Thread Form (ANPT)  
Dryseal American National Standard Taper Pipe Thread Form (NPTF)



taper per foot limits

nominal size (in)	threads per inch	projection* (in)	projection tolerance + / -	taper per foot limits		length L1	tap drill size** NPT, ANPT, NPTF
				min	max		
1/16	27	.312	.063	.719	.781	.160	C
1/8	27	.312	.063	.719	.781	.1615	Q
1/4	18	.459	.063	.719	.781	.2278	7/16
3/8	18	.454	.063	.719	.781	.240	9/16
1/2	14	.579	.063	.719	.781	.320	45/64
3/4	14	.565	.063	.719	.781	.339	29/32
1	11-1/2	.678	.094	.719	.781	.400	1-9/64
1-1/4	11-1/2	.686	.094	.719	.781	.420	1-31/64
1-1/2	11-1/2	.699	.094	.719	.781	.420	1-23/32
2	11-1/2	.667	.094	.719	.781	.436	2-3/16
2-1/2	8	.925	.094	.734	.781	.682	2-39/64
3	8	.925	.094	.734	.781	.766	3-15/64
3-1/2	8	.938	.125	.734	.781	.821	—
4	8	.950	.125	.734	.781	.844	—

\*Distance from small end of tap projects through L1 taper thread ring gage.

\*\*Recommended size given permits direct tapping without reaming the hole, but only gives a full thread for approximately the L1 length. Reprinted with permission from United States Cutting Tool Institute (USCTI). Published by Kennametal Inc. © 2014. All rights reserved.

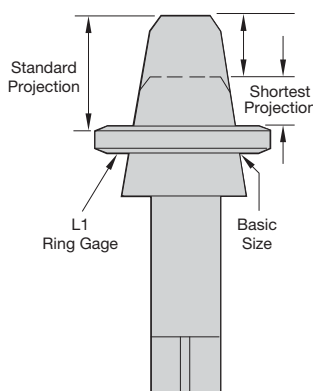
■ Pipe Taps

General-purpose pipe taps are appropriate for threading a wide variety of materials, both ferrous and non-ferrous.

Ground thread pipe taps are standard in American Standard Pipe Form (NPT) and American Standard Dryseal Pipe Form (NPFT). NPT threads require the use of a sealer, like Teflon® tape or pipe compound. Dryseal taps are used to tap fittings, which will give a pressure-tight joint without the use of a sealer.

The nominal size of a pipe tap is that of the pipe fitting to be tapped, not the actual size of the tap. The thread tapers 3/4" per foot.

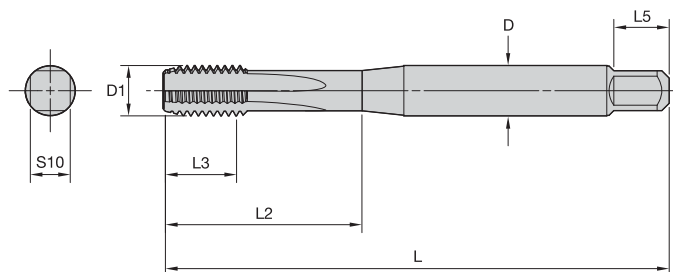
All pipe taps are furnished with 2-1/2-3-1/2 thread chamfer.



Short projection pipe taps are made with a projection shorter than standard for taper pipe tapping where the depth of tapping is limited.

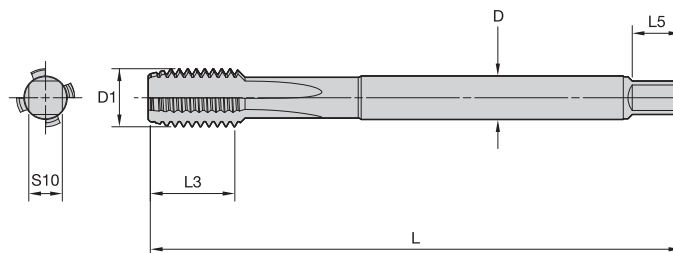
Special short projection taper pipe taps can be furnished with American National Standard Taper Pipe thread (ANPT) or Dryseal American National Standard Taper Pipe thread (NPTF, PTF-SAE Short, or PTF-SPL Extra Short).

For information on short projection pipe taps and hole preparation for NPT, NPTF, and ANPT internal pipe threads, consult WIDIA-GTD™ Technical Bulletins.



■ DIN 371

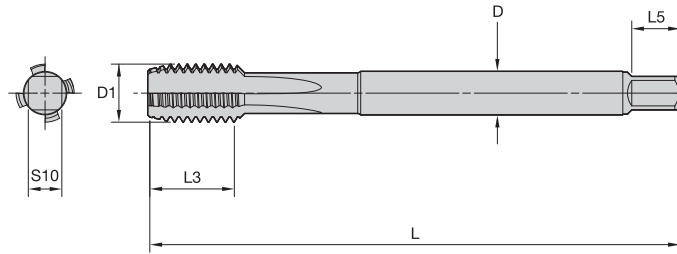
machine screw size number	nominal fraction diameter (in)	D	L	metric dimensions			
				L3	L2	L5	S10
4	-	3,5	56	8	18	6	2,7
5	-	4,0	56	9	20	6	3,0
6	-	4,0	56	9	20	6	3,0
8	-	4,5	63	11	21	6	3,4
10	-	6,0	70	12	25	8	4,9
-	1/4	7,0	80	15	30	8	5,5
-	5/16	8,0	90	15	35	9	6,2
-	3/8	10,0	100	19	39	11	8,0



■ DIN 376

nominal fraction diameter (in)	D	L	metric dimensions		
			L3	L5	S10
7/16	8	100	18	9	6,2
1/2	9	110	23	10	7,0
9/16	11	110	25	12	9,0
5/8	12	110	24	12	9,0
3/4	16	140	30	15	12,0
7/8	18	140	34	17	14,5
1	18	160	38	17	14,5

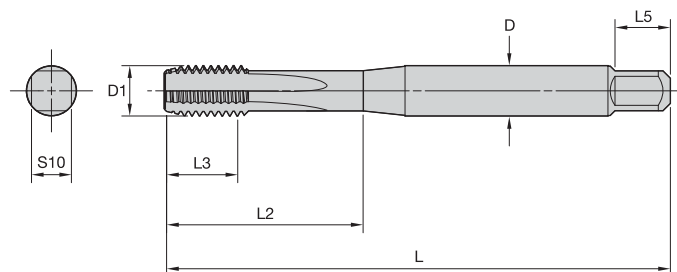




■ **DIN 374**

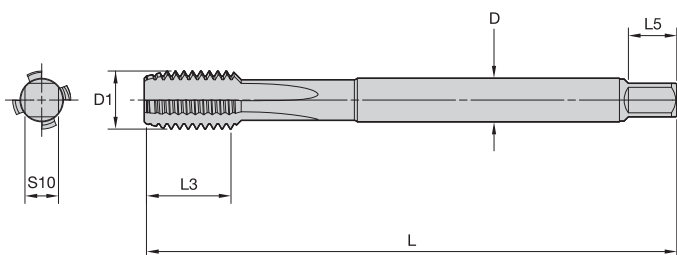
D1	pitch		D	L	metric dimensions		
	minimum	maximum			L3*	L5	S10
M8	0.2	0.75	6	80	18	8	4.9
M8	–	1	6	90	22	8	4.9
M9	0.2	0.75	7	80	18	8	5.5
M9	–	1	7	90	22	8	5.5
M10	0.2	1	7	90	20	8	5.5
M10	–	1.25	7	100	24	8	5.5
M11	0.35	1	8	90	20	9	6.2
M12	0.35	1.5	9	100	22	10	7
M14	0.35	1.5	11	100	22	12	9
M16	0.35	1.5	12	100	22	12	9
M16	–	2	12	110	32	12	9
M18	0.35	1.5	14	110	25	14	11
M18	–	2	14	125	34	14	11
M20	0.35	1.5	16	125	25	15	12
M20	–	2	16	140	34	15	12
M22	0.35	1.5	18	125	25	17	14.5
M22	–	2	18	140	34	17	14.5
M24	0.35	2	18	140	28	17	14.5
M27	0.35	2	20	140	28	19	16
M30	0.35	2	22	150	28	21	18
M30	–	3	22	180	45	21	18

\* Maximum



■ JIS Type 2 Metric Coarse

D1	pitch	D	L	metric dimensions		L5	S10
				L3	L2		
M3	0.5	4	46	11	19	6	3.2
M3.5	0.6	4	48	13	20	6	3.2
M4	0.7	5	52	13	21	7	4
M4.5	0.75	5	55	13	21	7	4
M5	0.8	5.5	60	16	24	7	4.5
M6	1	6	62	19	29	7	4.5



■ JIS Type 3 Metric Coarse

D1	pitch	D	L	metric dimensions		L5	S10
				L3	L		
M8	1.25	6.2	70	22	8	5	
M9	1.25	7	72	22	8	5.5	
M10	1.5	7	75	24	8	5.5	
M11	1.5	8	80	25	9	6	
M12	1.75	8.5	82	29	9	6.5	
M14	2	10.5	88	30	11	8	
M16	2	12.5	95	32	13	10	
M18	2.5	14	100	37	14	11	
M20	2.5	15	105	37	15	12	
M22	2.5	17	115	38	16	13	
M24	3	19	120	45	18	15	

**Through Holes  
Push Chips**



GUN™

LHSF



- GUN™ (spiral point) or LHSF (Left-Hand Spiral Flute).
- Ideal for materials with long chips.

**Blind Holes  
Pull Chips**



RHSF



- RHSF (Right-Hand Spiral Flute).
- Ideal for materials with long chips.

**Blind or Through Holes  
Store Chips**



STFL

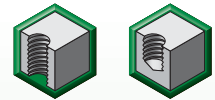


- STFL (Straight Flute).
- Ideal for materials with short chips.

**Blind or Through Holes  
No Chips**



Forming Tap



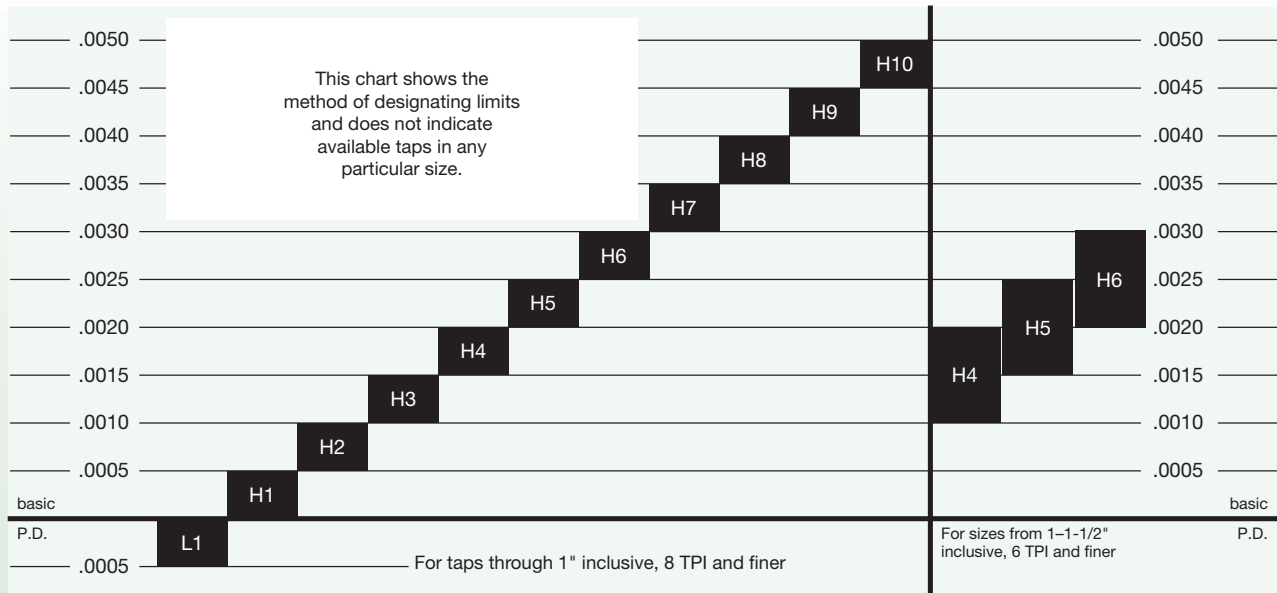
- Forming.
- Ideal for ductile materials <32 HRC.

In addition to the nominal size and pitch of a tap, there is another important dimensional factor to be considered when selecting a ground thread tap for a given job. This factor is the pitch diameter tap limit, "H" and "L". "H" represents (high) above basic pitch diameter; "L" (low) is below basic pitch diameter. Tap limits have been established to provide a choice in the selection of the tap size best suited to produce the class of thread desired.

**Figure 1** illustrates the numbering system and the .0005" diameter increment separation between successive limits. Because the starting point is basic pitch diameter, dividing the limit number by two establishes, in thousandths of an inch, the amount the maximum tap pitch diameter is above basic in the "H" series and the amount the minimum tap pitch diameter is under basic in the "L" series.

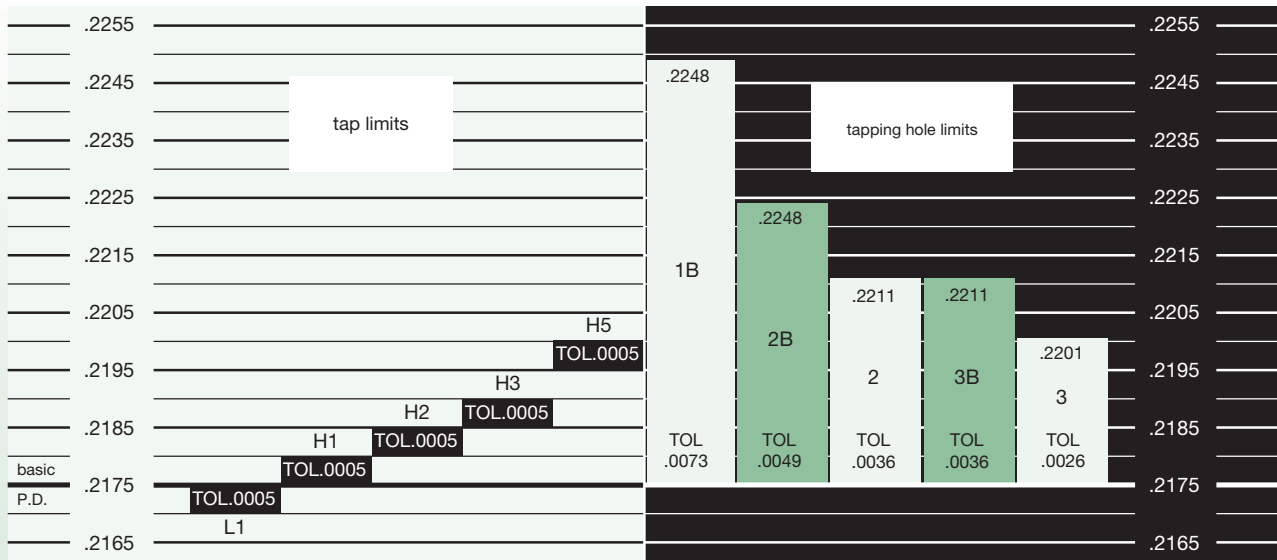
**Figure 2** illustrates the positioning of the tap limits in relation to the various classes of threads for a 1/4-20 size.

**Figure 1**

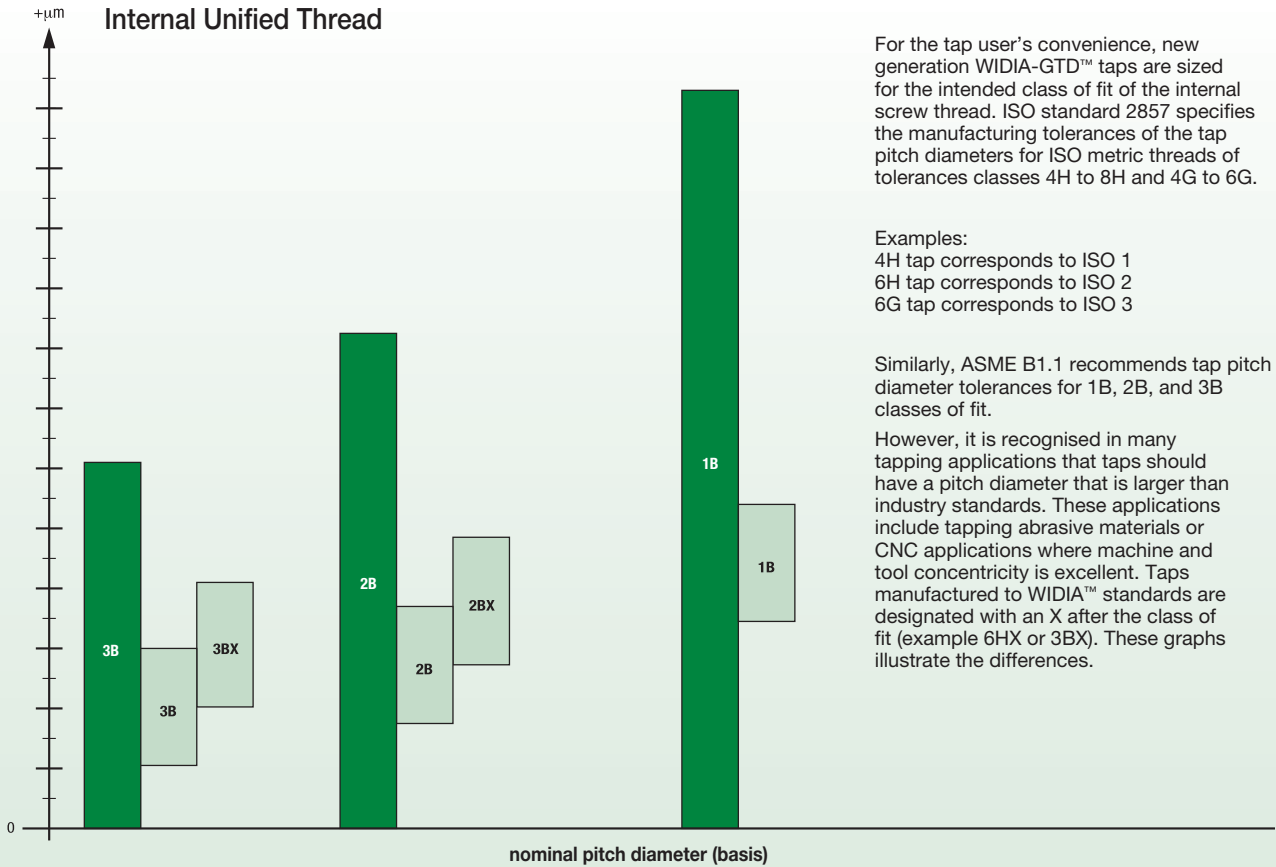


**Figure 2**

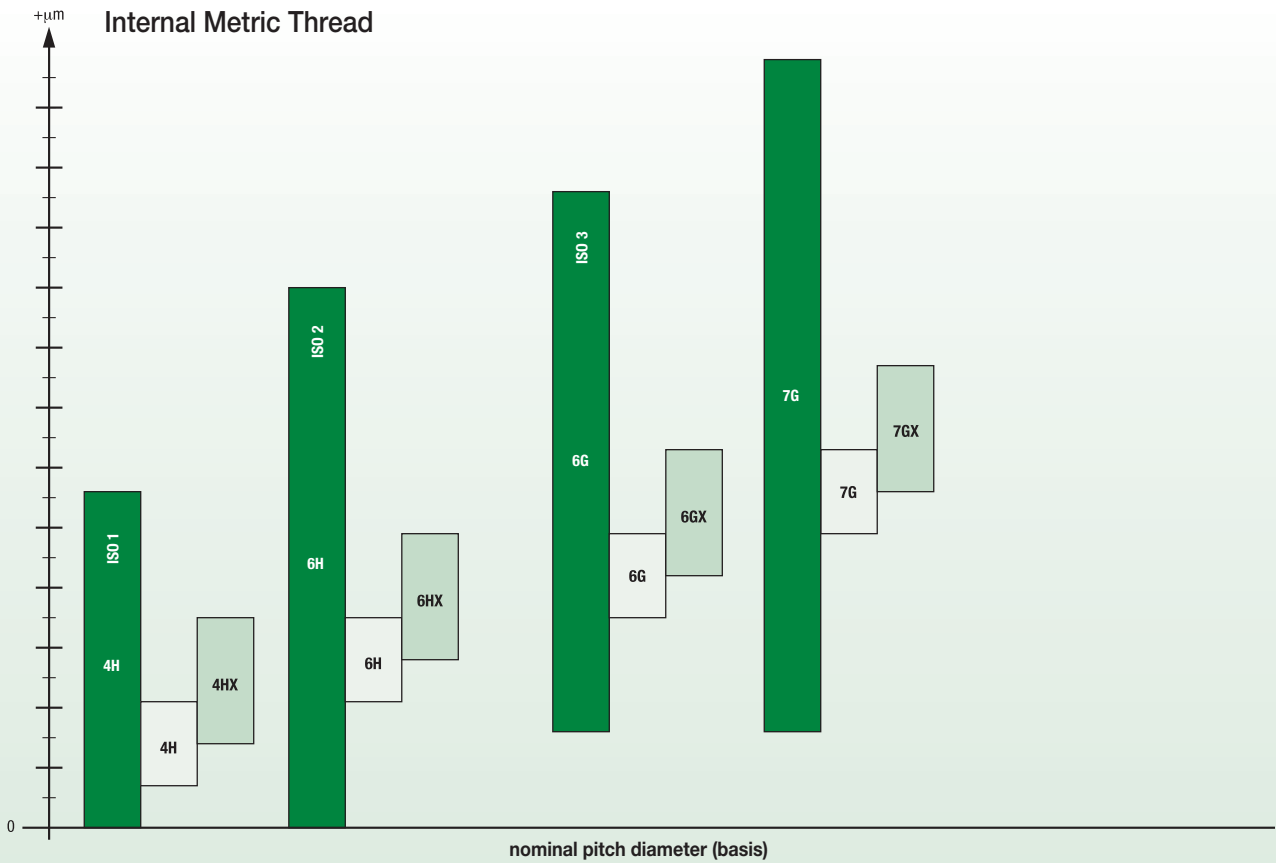
Class of Thread – 1/4-20 UNC and NC



**Internal Unified Thread**



**Internal Metric Thread**



It is generally recognised that, in mass production, it is impossible to reproduce in exact detail the theoretically perfect product as laid out on the drawing board. The allowed slight variation between the theoretically perfect product drawing and each unit of the actual product is called the tolerance.

**Allowance**

An intentional difference in correlated dimensions of mating parts. It is the minimum clearance or maximum interference between such parts.

**Angle of Thread**

The angle included between the flanks of the thread measured in an axial plane.

**Half Angle of Thread**

The angle included between a flank of the thread and the normal (90°) to the axis, measured in an axial plane.

**Lead of Thread**

The distance a screw thread advances axially in one turn. On a single-thread screw, the lead and pitch are identical. On a double thread, the lead is 2x pitch; on a triple thread, the lead is 3x pitch, etc.

**Major Diameter**

The largest diameter of a straight-screw thread.

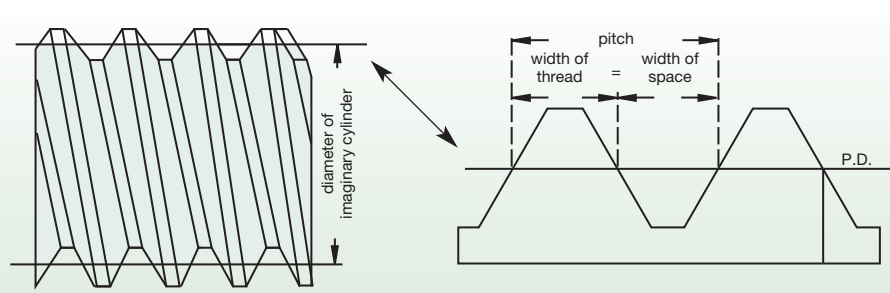
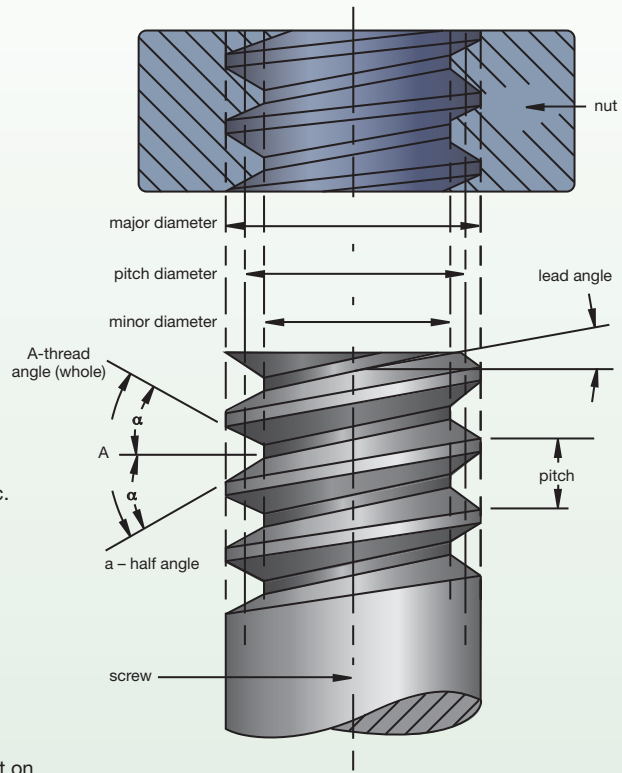
**Minor Diameter**

The smallest diameter of a straight-screw thread.

**Pitch**

The distance from a point on a screw thread to a corresponding point on the next thread measured parallel to the axis.

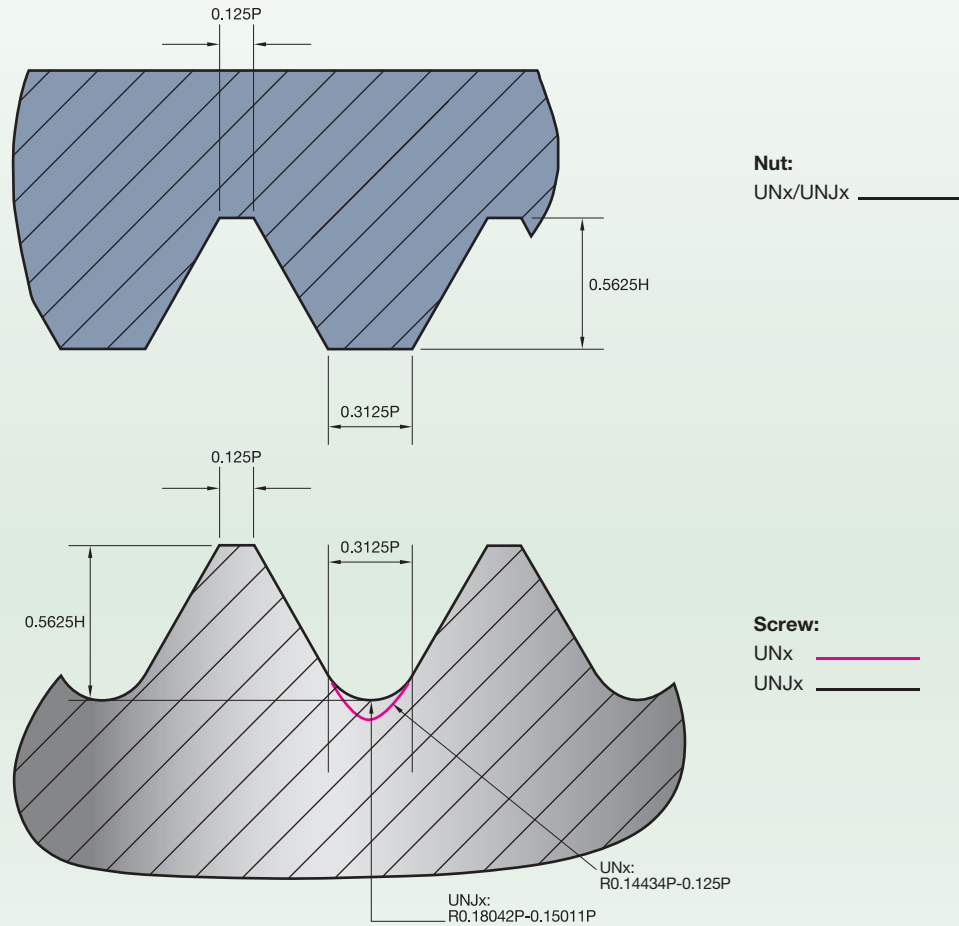
The pitch in inches =  $\frac{1}{\text{number of threads per inch}}$



**Pitch Diameter**

On a straight-screw thread, the diameter of an imaginary cylinder that would pass through the threads at such points as to make equal the width of the threads and the width of the spaces cut by the surface of the cylinder.

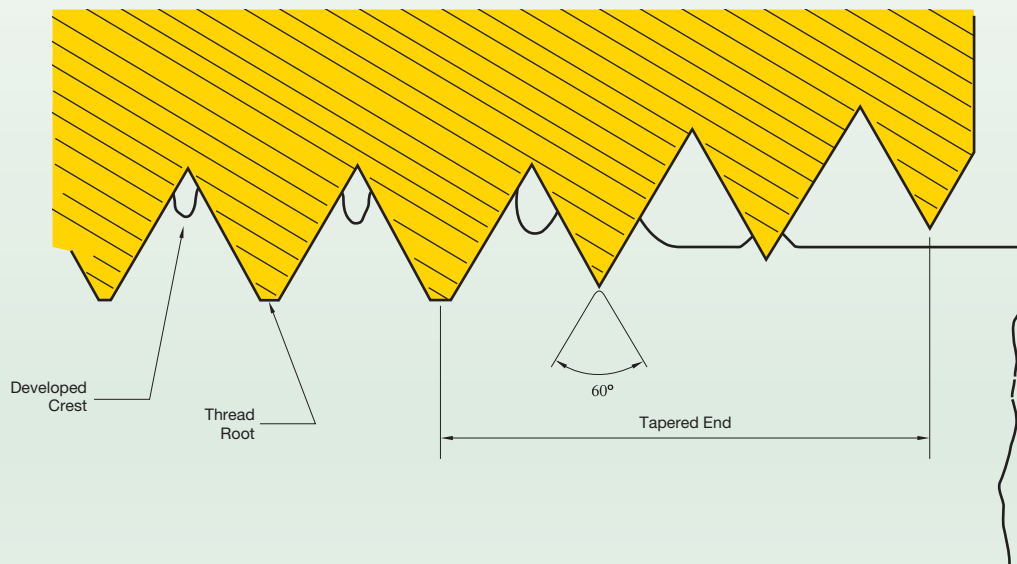
A thread system is available for aerospace and other applications where high fatigue strength is required. The UNJ thread form is defined by ASME B1.15 and is similar to Military Specification MIL-S-8879. Screw thread assemblies consist of external and internal threads. In order to minimise the stress on the external UNJ thread, a controlled root radius is required that is equal to  $0.15011P$  to  $0.18042P$ , where  $P$  is the thread pitch. Internal UNJ threads are not required to have a radius at either the major or minor diameters.



Because external UNJ threads must be produced with a defined root radius, standard UN tooling may not be used. However, internal UNF threads may be produced with ground thread UN taps sized to produce the proper class of fit. The tap does not need to be marked with a letter J. Attention must be paid to the tap drill since the minor diameter has to be specified so as to provide clearance with the root radius on the external thread.

For UNJ thread specifications, the reader is referred to ASME B1.15. Please note this standard includes Class 3 and Class 2 UNJ screw threads. However, only Class 3 UNJ threads meet the requirements of Military Specification MIL-S-8879. For Unified Inch (UN) thread specifications, refer to ASME B1.1.

Unlike cutting taps, which remove material, forming taps generate an internal screw thread by displacing material and forming it into the V-shaped thread. A common misconception is that a thread rolling action occurs. Instead, the threads are formed over the tapered entry section of the tap as the tap rotates into the hole. A succession of deeper penetrating lobes over the entry plastically displaces material radially between the tap's thread flanks until the entry length is reached. At this point, the thread is fully formed at the correct thread height.



Forming taps have numerous advantages over cutting taps. The most obvious advantage is that forming taps do not create chips. There are no chip removal problems. Bird nesting is a situation that occurs when chips wrap around the shank of spiral-fluted taps when tapping blind holes in long chipping materials. Forming taps help this to be avoided. Since forming taps avoid this problem, they are stronger and more resistant to breakage. Another misconception is that forming taps produce stronger threads. Although the forming process strain hardens the thread flanks, it has very little effect on the major diameter, the location where internal threads strip.

Forming taps can only be used in ductile materials. Due to increased friction relative to cutting, forming taps require higher torque than cutting taps. In some situations, oil-based lubrications are required, and this might not be convenient on CNC machining centres that use water soluble coolant. In this situation, the lubricant concentration should be increased.

Since forming taps displace material, larger diameter pre-tap holes are required. This is especially important when converting from cutting taps to forming taps. If a cutting tap hole size is used, the displaced material will over-fill the tap's threads and breakage will result. Please consult hole size charts for forming taps.



coating	properties and application	precautions
<b>Titanium Nitride (TiN)</b>	Proprietary TiN coating (hardness 2300 Vickers) offers significantly improved wear life and thread finish, often at higher tapping speeds, in a broad range of materials, especially steels, irons, and plastics. Golden colour.	Use with caution in non-ferrous materials such as aluminium because of tendency to gall.
<b>Titanium Carbonitride (TiCN)</b>	Proprietary TiCN coating (hardness 3000 Vickers) is harder, tougher, and more wear resistant than TiN under conditions of moderate cutting temperatures. Like TiN, TiCN may be used at higher cutting speeds in a broad range of materials, especially steels and irons. Blue-grey colour.	Use with caution in non-ferrous materials such as aluminium because of tendency to gall. TiCN is a better choice when used at extreme temperatures.
<b>Titanium Nitride + Chromium Carbide Carbon (TiN + CrC/C)</b>	Proprietary coating (hardness 2300 Vickers) that combines the wear resistance of smooth TiN coating with a lubricous top layer of chromium carbide carbon. Effective in stainless steel and non-ferrous materials including aluminium and titanium. Ideal choice for 300 series stainless steels, wrought, and die cast aluminiums. Black/grey colour.	Effective in both ferrous and non-ferrous materials.
<b>Titanium Aluminium Nitride (TiAlN)</b>	Nanolayer TiAlN coating (hardness 3300 Vickers) offers improved wear life and thread finish, especially in conditions where high temperatures can be generated. Use for PH stainless steels and nickel-based alloys like INCONEL®. Violet/grey colour.	Use with caution in non-ferrous materials because of tendency to gall.
<b>Chromium Nitride (CrN)</b>	CrN is medium hard (hardness 1800 Vickers) and has a lower wear resistance than TiN, TiCN, and TiAlN. However, unlike these coatings, CrN does not gall when used in some non-ferrous work materials. Use for brass, bronze, zinc alloys, and magnesium alloys. Silver colour.	Ineffective in ferrous materials.
<b>Nitride (MAXI #1)</b>	Hardened case extends wear life in abrasive materials. Use for aluminium and other non-ferrous materials.	Avoid on taper pipe, fast spiral, and small diameter (<#6) or fine pitch taps due to tendency for thread chipping.
<b>Oxide (SH-50)</b>	Helps prevent galling in ferrous (iron-based) materials. For free machining steel. Use for steels, stainless steels, and irons.	Has a tendency to cause galling in non-ferrous materials such as aluminium.
<b>Nitride and Oxide (SH-47)</b>	Combines the benefits of nitride and oxide surface treatments. For steels, stainless steels, and nickel alloys.	See precautions for nitride and oxide surface treatments.

Factors when trying to determine the best tapping speeds:

- Material to be tapped
- Length of chamfer on tap
- Percentage of full thread to be cut
- Length of hole (depth of thread)
- Pitch of thread
- Cutting fluids
- Machine equipment
- Horizontal or vertical tapping

The best and most efficient operating speeds for taps cannot be calculated with the same certainty, as for many other metalcutting tools.

With other tools, the feed per revolution can be set at any desired point and can be varied as conditions demand. Taps, on the other hand, must always be advanced at a rate equal to one pitch for every revolution. The style of tap may vary the conditions.

For example, with a bottoming tap, the first thread on each land cuts the full height of thread, while, with a taper or starting tap, a number of threads do their share of the cutting before the full height of thread is reached.

The depth of thread also varies, depending on the pitch. The coarser the thread, the greater the advance of the tap per revolution and the greater the amount of material removed.

The method of feeding the tap, and the type of equipment for driving, also influences the permissible speeds. If taps are mechanically fed at the proper rate of advance, they can be operated at higher speeds than if they are required to feed themselves and pull some part of the machine along with them.

**Speeds may be modified to take into account any or all of these factors:**

- Speeds must be lowered as length of thread increases because, in deep thread holes, the accumulated chips increase friction and interfere with lubrication.
- Bottoming taps must be run slower than plug taps.
- Tapping full height of thread calls for slower speed than if the commercial 75% height only is required.
- Coarse-thread taps in the larger diameters should be run more slowly than fine-thread taps of the same diameters.
- The quantity and quality of cutting fluid may affect the permissible speeds as much as 100%.
- Taper threaded taps, such as pipe taps, should be operated from 1/2–3/4 the speed of a straight thread tap of comparable major diameter.

### ■ RPM Formulas

SFM = Surface Feet per Minute  
 RPM = Revolutions per Minute  
 IPM = Inches per Minute  
 TPI = Threads per Inch

S m/m = Surface Metres per Minute  
 $\pi = 3.1416$   
 mm/min = millimetres per minute  
 P = Pitch (1/number of threads per inch)

#### Inch Sizes

SFM	=	$\frac{\text{RPM} \times \text{tool diameter}}{3.82}$	or	0.26 x RPM x tool diameter
RPM	=	$\frac{3.82 \times \text{SFM}}{\text{tool diameter}}$		
IPM	=	$\frac{\text{RPM}}{\text{TPI}^*}$	or	*P x RPM

#### Metric Sizes

S m/m	=	$\frac{\pi \times \text{tool diameter} \times \text{RPM}}{1000}$
RPM	=	$\frac{\text{mm/m} \times 1000}{\pi \times \text{tool diameter}}$
mm/min	=	mm P x RPM

■ **UNC/UNF and NPT/NPTF**

tap size	taper pipe taps	surface feet per minute (SFM)																	
		5'	10'	15'	20'	25'	30'	40'	50'	60'	70'	80'	90'	100'	110'	120'	130'	140'	150'
		revolutions per minute (RPM)																	
0	—	318	637	955	1273	1592	1910	2546	3183	3820	4456	5093	5729	6366	7003	7639	8276	8913	9549
1	—	273	546	819	1046	1308	1570	2093	2617	3140	3663	4186	4710	5233	5756	6279	6805	7326	1849
2	—	212	424	637	888	1110	1333	1777	2221	2665	3109	3554	3999	4442	4886	5330	5774	6218	6662
3	—	191	382	573	772	964	1157	1543	1929	2315	2701	3086	3472	3858	4244	4629	5015	5401	5787
4	—	174	347	521	682	853	1023	1364	1705	2046	2387	2728	3069	3411	3751	4092	4434	4775	5115
5	—	147	294	441	611	764	917	1222	1528	1833	2139	2445	2750	3056	3361	3667	3973	4278	4584
6	—	136	273	409	553	691	829	1106	1382	1659	1935	2212	2488	2766	3042	3318	3595	3871	4148
8	—	119	239	358	466	583	699	932	1165	1398	1631	1864	2097	2330	2563	2796	3029	3262	3495
10	—	101	201	302	402	502	603	804	1005	1205	1406	1607	1808	2009	2210	2411	2612	2813	3014
12	—	87	174	260	354	442	531	707	884	1061	1238	1415	1592	1769	1945	2122	2300	2476	2653
1/4	—	76	153	229	306	382	458	611	764	917	1070	1222	1375	1528	1681	1833	1986	2139	2292
5/16	—	62	123	185	245	306	367	489	611	733	856	978	1100	1222	1345	1467	1589	1711	1833
3/8	—	50	101	151	204	255	305	407	509	611	713	815	917	1019	1120	1222	1324	1426	1528
7/16	1/8	43	87	130	175	219	262	349	437	524	611	698	786	873	960	1048	1135	1222	1310
1/2	—	38	76	115	153	191	229	305	382	458	535	611	688	764	840	917	993	1070	1146
9/16	1/4	34	68	102	137	172	206	274	342	410	478	547	616	683	752	820	888	952	1020
5/8	—	32	64	96	122	153	183	244	306	367	428	489	550	611	672	733	794	856	917
11/16	3/8	28	55	83	111	138	167	222	278	333	389	444	500	556	611	667	722	778	833
3/4	—	25	51	76	102	128	153	203	255	305	357	407	458	509	560	611	662	713	764
7/8	1/2	22	43	65	87	109	131	175	218	262	306	350	392	437	480	524	568	611	655
1	—	19	38	57	76	96	115	153	191	230	268	305	344	382	420	458	497	535	573
1-1/8	3/4	17	34	51	68	84	102	136	170	204	238	272	306	340	373	407	441	475	509
1-1/4	—	15	31	46	61	76	92	122	153	183	214	244	275	305	336	367	397	428	458
1-3/8	1	14	28	42	56	69	83	111	139	167	194	222	250	278	306	333	361	389	417
1-1/2	—	13	25	38	51	63	76	102	127	153	178	204	229	255	280	305	331	356	382
1-5/8	—	12	23	35	47	59	71	94	118	141	165	188	212	235	259	282	306	329	353
1-3/4	—	11	22	33	44	55	65	87	109	131	153	175	196	218	240	262	284	306	327
1-7/8	—	10	20	30	41	51	61	81	102	122	143	163	183	204	224	244	265	285	306
2	—	9	19	29	38	48	57	76	96	115	134	153	172	191	210	229	248	267	287

■ **Metric**

metric taps	surface feet per minute (SFM)																	
	5'	10'	15'	20'	25'	30'	40'	50'	60'	70'	80'	90'	10'	110'	120'	130'	140'	150'
	revolutions per minute (RPM)																	
M1	490	979	1469	1959	2449	2938	3918	4897	5877	6856	7836	8815	9795	10774	11754	12733	13713	14692
M2	242	484	725	967	1209	1451	1934	2418	2901	3385	3868	4352	4835	5319	5803	6286	6770	7253
M3	162	324	486	647	809	971	1295	1619	1942	2266	2590	2914	3237	3561	3885	4208	4532	4856
M3.5	138	277	415	554	692	830	1107	1384	1661	1938	2214	2491	2768	3045	3322	3599	3875	4152
M4	122	243	365	487	608	730	973	1217	1460	1703	1946	2190	2433	2676	2920	3163	3406	3650
M5	97	194	291	388	485	582	776	970	1163	1357	1551	1745	1939	2133	2327	2521	2715	2905
M6	81	162	243	324	405	486	647	809	971	1133	1295	1457	1619	1781	1942	2104	2266	2428
M7	69	138	208	277	346	415	554	692	830	969	1107	1246	1384	1522	1661	1799	1938	2076
M8	61	121	182	243	303	364	485	606	728	849	970	1091	1213	1334	1455	1577	1698	1819
M10	48	97	145	194	242	291	388	485	582	679	776	873	970	1067	1163	1260	1357	1454
M12	40	81	121	162	202	243	324	405	486	567	647	728	809	890	971	1052	1133	1214
M14	35	69	104	139	173	208	277	347	416	485	555	624	693	763	832	901	971	1040
M16	30	61	91	121	152	182	243	303	364	424	485	546	606	667	728	788	849	910
M18	27	54	81	108	135	162	216	269	323	377	431	485	539	593	647	700	754	808
M20	24	49	73	97	121	146	194	243	291	340	388	437	485	534	582	631	680	728
M22	22	44	66	88	110	132	176	221	265	309	353	397	441	485	529	573	618	662
M24	20	40	61	81	101	121	162	202	243	283	323	364	404	445	485	526	566	606
M27	18	36	54	72	90	108	144	180	216	252	287	323	359	395	431	467	503	539
M30	16	32	49	65	81	97	129	162	194	226	259	291	323	356	388	420	453	485

Partial List of Solutions to Tapping Problems

application	symptom	common cause	remedy
general	gage out of limits	tap size and gage mismatch	select tap size for gage
	oversize thread	alignment, spindle feed	correct
	oversize at top	runout or alignment	correct
	go gage binds part way	worn tool, tap cuts off lead	replace tap, synchronous holder
	thread shaving	feed error, high axial force	programme, synchronous holder
	chipping	high cutting force, worn tap	tap geometry, replace tap
	breakage	chip jamming flutes	tap geometry, tapping depth
	—	worn tool, high torque	replace tap with new tool
	short life, low speed	excessive wear	SC or HSS-E-PM HP taps
steel	birdnest blind hole	long, ductile chips	GT30 GP6505 (oxide), peck feed
	chipping	high material hardness	GT00, GT02 WP31MG (TiN)
	breakage in blind holes	hole depth >2D, chip jamming	GT04 WH36MG (TiN/MoS <sub>2</sub> )
stainless steel	oversize thread, low life	galling	GT20, GT30 GM6515 (TiN-CrC/C)
	short life	work hardened core hole	replace drill
cast iron	excessive wear	abrasion	GT40 GP6520 (TiCN)
aluminium, cast	excessive wear	high silicon	GT40 GP6520 (TiCN)
aluminium, wrought	oversize thread	galling	GT70, GT80 WN48EG (DLC)
nickel, cobalt alloys	short life	high cutting temperature	GT10, GT12 WS32MG (TiCN)
titanium	short life	high cutting temperature	GT14, GT16 WN35MG (TiN-DLC)

**Thread Mills**

	<b>vibration marks</b>	<b>major crest wear</b>	<b>edge chipping</b>	<b>cone-shaped thread</b>	<b>entry marks</b>
<b>cutting speed</b>	check	reduce	—	—	—
<b>feed per tooth</b>	check	increase	reduce	—	—
<b>workpiece clamping</b>	improve	improve	improve	—	improve
<b>machine tool stability</b>	improve	improve	improve	—	improve
<b>cantilever arm</b>	shorten	shorten	—	—	shorten
<b>helix angle</b>	increase	reduce	—	—	—
<b>radial runout</b>	check	check	—	—	—
<b>coating</b>	—	improve	improve	—	—
<b>milling operation</b>	—	climb mill	climb mill	climb mill	—
<b>line feed/entry ramp</b>	check	check	—	—	improve
<b>coolant pressure</b>	—	check (>20 bar, 290 psi)	check (>20 bar, 290 psi)	—	—

drill size	decimal (in)	drill size	decimal (in)	drill size	decimal (in)	drill size	decimal (in)	drill size	decimal (in)	drill size	decimal (in)
0,30mm	.0118	54	.0550	3,10mm	.1220	5,50mm	.2165	8,50mm	.3346	9/16	.5625
0,32mm	.0126	1,40mm	.0551	1/18	.1250	7/32	.2188	8,60mm	.3386	14,50mm	.5709
80	.0135	1,45mm	.0571	3,20mm	.1260	5,60mm	.2205	R	.3390	37/64	.5781
0,35mm	.0138	1,50mm	.0591	30	.1285	2	.2210	8,70mm	.3425	14,75mm	.5807
79	.0145	53	.0595	3,30mm	.1299	5,70mm	.2244	11/32	.3438	15,00mm	.5906
0,38mm	.0150	1,55mm	.0610	3,40mm	.1339	1	.2280	8,80mm	.3465	19/32	.5938
1/64	.0156	1/16	.0625	29	.1360	5,80mm	.2283	S	.3480	15,25mm	.6004
0,40mm	.0157	1,60mm	.0630	3,50mm	.1378	5,90mm	.2323	8,90mm	.3504	39/64	.6094
78	.0160	52	.0635	28	.1405	A	.2340	9,00mm	.3543	15,50mm	.6102
0,42mm	.0165	1,65mm	.0650	9/64	.1406	15/64	.2344	T	.3580	15,75mm	.6201
0,45mm	.0177	1,70mm	.0669	3,60mm	.1417	6,00mm	.2362	9,10mm	.3583	5/8	.6250
77	.0180	51	.0670	27	.1440	B	.2380	23/64	.3594	16,00mm	.6299
0,48mm	.0189	1,75mm	.0689	3,70mm	.1457	6,10mm	.2402	9,20mm	.3622	16,25mm	.6398
0,50mm	.0197	50	.0700	26	.1470	C	.2420	9,30mm	.3661	41/64	.6406
76	.0200	1,80mm	.0709	25	.1495	6,20mm	.2441	U	.3680	16,50mm	.6496
75	.0210	1,85mm	.0728	3,80mm	.1496	D	.2460	9,40mm	.3701	21/32	.6562
0,55mm	.0217	49	.0730	24	.1520	6,30mm	.2480	9,50mm	.3740	16,75mm	.6594
74	.0225	1,90mm	.0748	3,90mm	.1535	1/4, E	.2500	3/8	.3750	17,00mm	.6693
0,60mm	.0236	48	.0760	23	.1540	6,40mm	.2520	V	.3770	43/64	.6719
73	.0240	1,95mm	.0768	5/32	.1562	6,50mm	.2559	9,60mm	.3780	17,25mm	.6791
0,62mm	.0244	5/64	.0781	22	.1570	F	.2570	9,70mm	.3819	11/16	.6875
72	.0250	47	.0785	4,00mm	.1575	6,60mm	.2598	9,80mm	.3858	17,50mm	.6890
0,65mm	.0256	2,00mm	.0787	21	.1590	G	.2610	W	.3860	45/64	.7031
71	.0260	2,05mm	.0807	20	.1610	6,70mm	.2638	9,90mm	.3898	18,00mm	.7087
0,70mm	.0276	46	.0810	4,10mm	.1614	17/64	.2656	25/64	.3906	23/32	.7188
70	.0280	45	.0820	4,20mm	.1654	H	.2660	10,00mm	.3937	18,50mm	.7283
69	.0292	2,10mm	.0827	19	.1660	6,80mm	.2677	X	.3970	47/64	.7344
0,75mm	.0295	2,15mm	.0846	4,30mm	.1693	6,90mm	.2717	10,20mm	.4016	19,00mm	.7480
68	.0310	44	.0860	18	.1695	I	.2720	Y	.4040	3/4	.7500
1/32	.0312	2,20mm	.0866	11/64	.1719	7,00mm	.2756	13/32	.4062	49/64	.7656
0,80mm	.0315	2,25mm	.0886	17	.1730	J	.2770	Z	.4130	19,50mm	.7677
67	.0320	43	.0890	4,40mm	.1732	7,10mm	.2795	10,50mm	.4134	25/32	.7812
66	.0330	2,30mm	.0906	16	.1770	K	.2810	27/64	.4219	20,00mm	.7874
0,85mm	.0335	2,35mm	.0925	4,50mm	.1772	9/32	.2812	10,80mm	.4252	51/64	.7969
65	.0350	42	.0935	15	.1800	7,20mm	.2835	11,00mm	.4331	20,50mm	.8071
0,90mm	.0354	3/32	.0938	4,60mm	.1811	7,30mm	.2874	7/16	.4375	13/16	.8125
64	.0360	2,40mm	.0945	14	.1820	L	.2900	11,20mm	.4409	21,00mm	.8268
63	.0370	41	.0960	4,70mm, 13	.1850	7,40mm	.2913	11,50mm	.4528	53/64	.8281
0,95mm	.0374	2,45mm	.0965	3/16	.1875	M	.2950	29/64	.4531	27/32	.8438
62	.0380	40	.0980	4,80mm, 12	.1890	7,50mm	.2953	11,80mm	.4646	21,50mm	.8465
61	.0390	2,50mm	.0984	11	.1910	19/64	.2969	15/32	.4688	55/64	.8594
1,00mm	.0394	39	.0995	4,90mm	.1929	7,60mm	.2992	12,00mm	.4724	22,00mm	.8661
60	.0400	38	.1015	10	.1935	N	.3020	12,20mm	.4803	7/8	.8750
59	.0410	2,60mm	.1024	9	.1960	7,70mm	.3031	31/64	.4844	22,50mm	.8858
1,05mm	.0413	37	.1040	5,00mm	.1969	7,80mm	.3071	12,50mm	.4921	57/64	.8906
58	.0420	2,70mm	.1063	8	.1990	7,90mm	.3110	1/2	.5000	23,00mm	.9055
57	.0430	36	.1065	5,10mm	.2008	5/16	.3125	12,80mm	.5039	29/32	.9062
1,10mm	.0433	7/64	.1094	7	.2010	8,00mm	.3150	13,00mm	.5118	59/64	.9219
1,15mm	.0453	35	.1100	13/64	.2031	O	.3160	33/64	.5156	23,50mm	.9252
56	.0465	2,80mm	.1102	6	.2040	8,10mm	.3189	13,20mm	.5197	15/16	.9375
3/64	.0469	34	.1110	5,20mm	.2047	8,20mm	.3228	17/32	.5312	24,00mm	.9449
1,20mm	.0472	33	.1130	5	.2055	P	.3230	13,50mm	.5315	61/64	.9531
1,25mm	.0492	2,90mm	.1142	5,30mm	.2087	8,30mm	.3268	13,80mm	.5433	24,50mm	.9646
1,30mm	.0512	32	.1160	4	.2090	21/64	.3281	35/64	.5469	31/32	.9688
55	.0520	3,00mm	.1181	5,40mm	.2126	8,40mm	.3307	14,00mm	.5512	25,00mm	.9843
1,35mm	.0531	31	.1200	3	.2130	Q	.3320	14,25mm	.5610	63/64	.9844
										1"	1.0000

■ Metric    
 ■ Fractional    
 ■ Wire gage    
 ■ Letter size

Knowing the hardness of the work material to be tapped is essential in selecting the best tap for the job.

10 mm/min ball 3000 kg	120° cone 150 kg	1/16" ball 100 kg	model C	1000 lb per sq. in.	10 mm/min ball 3000 kg	120° cone 150 kg	1/16" ball 100 kg	model C	1000 lb per sq. in.
Brinell	Rockwell C	Rockwell B	Shore Scleroscope	tensile strength	Brinell	Rockwell C	Rockwell B	Shore Scleroscope	tensile strength
800	72	-	100	-	276	30	105	42	136
780	71	-	99	-	269	29	104	41	132
760	70	-	98	-	261	28	103	40	129
745	68	-	97	367	258	27	102	39	127
725	67	-	96	357	255	26	102	39	125
712	66	-	95	350	249	25	101	38	123
682	65	-	93	337	245	24	100	37	119
668	64	-	91	326	240	23	99	36	117
652	63	-	89	318	237	23	99	35	115
626	62	-	87	306	229	22	98	34	113
614	61	-	85	299	224	21	97	33	110
601	60	-	83	292	217	20	96	33	107
590	59	-	81	290	211	19	95	32	104
576	57	-	79	281	206	18	94	32	102
552	56	-	76	270	203	17	94	31	100
545	55	-	75	268	200	16	93	31	98
529	54	-	74	259	196	15	92	30	96
514	53	120	72	254	191	14	92	30	94
502	52	119	70	247	187	13	91	29	92
495	51	119	69	244	185	12	91	29	91
477	49	118	67	233	183	11	90	28	90
461	48	117	66	227	180	10	89	28	89
451	47	117	65	223	175	9	88	27	86
444	46	116	64	219	170	7	87	27	84
427	46	115	62	209	167	6	87	27	82
415	44	115	60	204	165	5	86	26	81
401	43	114	58	196	163	4	85	26	80
388	42	114	57	191	160	3	84	25	78
375	41	113	55	184	156	2	83	25	76
370	40	112	54	182	154	1	82	25	75
362	39	111	53	179	152	-	82	24	74
351	38	111	51	173	150	-	81	24	74
346	37	110	50	170	147	-	80	24	72
341	37	110	49	168	145	-	79	23	71
331	36	109	47	163	143	-	79	23	70
323	35	109	46	158	141	-	78	23	69
311	34	108	46	153	140	-	77	22	69
301	33	107	45	148	135	-	75	22	67
293	32	106	44	144	130	-	72	22	65
285	31	105	43	140	-	-	-	-	-

material number	DIN EN - D	AFNOR - F	BS - UK	JIS
0.6010	GG10	—	Grade 100	FC 100
0.6015	GG15	FGL 150	Grade 150	FC 150
0.6020	GG20	FGL 200	Grade 220	FC 200
0.6025	GG25	FGL 250	Grade 250, 260	FC 250
0.6030	GG30	FGL 300	Grade 300	FC 300
0.6035	GG35	FGL 350	Grade 350	FC 350
0.6655	—	L-NUC 15 6 2	F1	—
0.6656	—	L-NUC 15 6 3	F1	—
0.6660	—	L-NC 20 2	F2	—
0.6661	—	L-NC 20 3	F2	—
0.6676	—	L-NC 30 3	F3	—
0.7040	GGG40	FGS 400-15	Grade 420/12	FCD 400
0.7043	GGG40.3	FGS 370-17	Grade 370/12	FCD 370
0.7050	GGG50	FGS 500-7	Grade 500/7	FCD 500
0.7060	GGG60	FGS 600-3	Grade 600/3	FCD 600
0.7070	GGG70	FGS 700-2	Grade 700/2	FCD 700
0.7080	GGG80	FGS 800-2	Grade 800/2	FCD 800
0.7652	—	S-NM 13 7	S 6	—
0.7660	—	S-NC 20 2	S 2	—
0.7661	—	S-NC 20 3	S 2	—
0.7670	—	S-N 22	S 2 C	—
0.7673	—	S-NM 23 4	S 2 M	—
0.7676	—	S-NC 30 3	S 3	—
0.7677	—	S-NC 30 1	S 3	—
0.8035	GTW35	MB 35-7	W 35-04	FCMW 330
0.8038	—	MB 380-12	—	—
0.8040	GTW40	MB 400-5	W 40-05	FCMW 370
0.8045	GTW45	MB 450-7	W 45-07	FCMWP 440
0.8135	GTS35	MN 350-10	B 35-12	FCMB 340
0.8145	GTS45	MP 50-5	P 45-06	—
0.8155	GTS55	MP 60-3	P 55-04	—
0.8165	GTS65	—	P 65-02	FCMP 540
0.8170	GTS70	MP 70-2	P 70-02	FCMP 690
0.9620	X 260 NiCr 4-2	—	Grade 2 A	—
0.9625	X 330 NiCr 4-2	—	Grade 2 B	—
0.9630	300 CrNiSi 9-5-2	—	Grade 2 C, D, E	—
0.9635	300 CrMo 15-3	—	Grade 3 A, B	—
0.9640	300 CrMoNi 15-2-1	—	Grade 3 A, B	—
0.9645	260 CrMoNi 20-2-1	—	Grade 3 C	—
0.9650	G-X 260 Cr 27	—	Grade 3 D	—
0.9655	300 CrMo 27-1	—	Grade 3 E	—
1.0301	C 10	XC 10	045 M 10040 A 10	S 10 C
1.0401	C 15	XC 12, XC 18	080 M 15	S 15 C
1.0402	C 22	C 22, XC 18, XC 25	1 C 22, 070 M 20	S 20 C, S 2 C
1.0406	C 25	1 C 25	070 M 26	S 25 C
1.0501	C 35	XC 38, 1 C 35	080 M 36, 1 C 35	S 35 C
1.0503	C 45	1 C 45, XC 48 H 1	1 C 45, 080 M 46	S 45 C
1.0511	C 40	1 C 40, XC 42 H 1	080 M 40, 1 C 40	S 40 C
1.0528	C 30	—	1 C 30, XC 32	S 30 C
1.0535	C 55	1 C 55, XC 55 H 1	1 C 55, 070 M 55	S 55 C
1.0540	C 50	1 C 50	1 C 50, 080 M50	S 50 C
1.0570	S355J2G3	E 36-3, E 36-4	Fe 510 D1 FF, 50/35	SM 490 , SM 520 B
1.0601	C 60	1 C 60, AF 70 C 55	1 C 60, 080 A 67	S 58 C
1.0715	9 SMn 28	S 250	080 M 15, 230 M 07	SUM 22
1.0718	9 SMnPb 28	S 250 Pb	—	SUM 22 L, SUM 23 L
1.0721	10 S 20	13 MF 4, 10 F 1	210 M 15	—
1.0722	10 SPb 20	CC 10 Pb, 10 PbF 2	—	SUM 12
1.0726	35 S 20	35 MF 6	212 M 36	SUM 41
1.0727	45 S 20	45 MF 61, 45 MF 4	212 M 36	SUM 42
1.0728	60 S 20	—	—	—
1.0736	9 SMn 36	S 300	240 M 07	SUM 25
1.0737	9 SMnPb 36	S 300 Pb	—	SUM 24 L
1.1121	Ck 10 (C 10 E)	XC 10	045 M 10, 040 A 10	S 9 Ck, S 10 C
1.1141	Ck 15 (C 15 E)	XC 12, XC 15	080 M 15, 040 A 15	S 15, S 15 Ck
1.1151	C 22 E	2 C 22, XC 18/25	055 M 15	S 20 C, S 20 Ck, S 22 C
1.1157	40 Mn 4	35 M 5, 40 M 5	150 M 36	—
1.1158	C 25 E	2 C 25, XC 25	070 M 26	S 25 C, S 28 C



UNI - I	UNE - E	AISI - US	condition	material group
G 10	FG 10	Class 20 B	U	15
G 15	FG 15	Class 25 B	U	15
G 20	FG 20	Class 30 B	U	16
G 25	FG 25	Class 40 B	U	16
G 30	FG 30	Class 45 B	U	16
G 35	FG 35	Class 50 B	U	16
—	—	—	GG/AU	17
—	—	—	GG/AU	17
—	—	—	GG/AU	17
—	—	—	GG/AU	18
—	—	—	GG/AU	31
GS 400-12	—	Grade 60-40-18	U	17
—	—	—	U	17
GS 500-7	—	Grade 65-45-12	U	17
GS 600-3	—	Grade 80-55-06	U	18
GS 700-2	—	Grade 100-70-03	U	18
GS 800-2	—	Grade 120-90-02	U	18
—	—	—	GGG/AU	17
—	—	—	GGG/AU	17
—	—	—	GGG/AU	18
—	—	—	GGG/AU	17
—	—	—	GGG/AU	17
—	—	—	GGG/AU	31
—	—	—	GGG/AU	31
—	—	—	G	20
W 38-12	—	—	G	19
W 40-05	—	—	G	19
W 45-07	—	—	G	19
B 35-10	Type A	Grade 22010, 32510	G	19
P 45-06	Type E	—	G	19
P 55-04	Type C	—	G	20
P 65-02	—	—	G	20
P 70-02	—	—	G	20
—	—	—	GO	40
—	—	—	GO	40
—	—	—	GO	40
—	—	—	GO	40
—	—	—	GO	40
—	—	—	GO	40
—	—	—	GO	40
—	—	—	GO	40
—	—	—	GO	40
C 10	F. 1511	1010	—	1
C 15, C 16	F. 111	1015	—	1
1 C 22, C 20, C 21	1 C 22, F. 112	1020, 1023	—	1
C 25, 1 C 25	—	1025	var <sup>1</sup>	2-3
C 35, 1 C 35	1 C 35, F. 113	1035	var <sup>1</sup>	2-3
C 45, 1 C 45	1 C 45, F. 114	1045	var <sup>1</sup>	2-3
1 C 40	1 C 40, F. 114.	1040	var <sup>1</sup>	2-3
1 C 30	1 C 30	1030	var <sup>1</sup>	2-3
C 55, 1 C 55	1 C 55	1055	var <sup>1</sup>	4-5
1 C 50	1 C 50	1050	var <sup>1</sup>	2-3
Fe 510 C FN	AE 355 D, Fe 510 D1 FF	—	—	2
C 60, 1 C 60	1 C 60	1060	var <sup>1</sup>	4-5
CF 9 SMn 28, CF 9 M 07	F. 2111	1213	1	—
CF 9 SMnPb 28	F. 2112	12 L 14, 12 L 13	—	1
CF 10 S 20	F. 2121	1102, 1108, 1109	—	1
CF 10 SPb 20	F. 2122	1108, 11 L 08	—	1
CF 35 SMn 10	F. 2131, F. 210.	1141, 1140	var <sup>1</sup>	2-3
CF 44 SMn 28	F. 2133	1146	var <sup>1</sup>	2-3
—	—	1151	var <sup>1</sup>	4-5
CF 9 SMn 36	F. 2113	1215	—	1
CF 9 SMnPb 36	F. 2114	12 L 14	—	1
C10, 2 C 10	F. 1510, C 10	1010	—	1
C 15, C 16	F. 1110, F. 1511	1015	—	1
C 20, C 25	F. 1120	1020, 1023	—	1
—	—	1035, 1041	var <sup>1</sup>	2-3
C 25	F. 1120	1025	var <sup>1</sup>	2-3

material number	DIN EN - D	AFNOR - F	BS - UK	JIS
1.1170	28 Mn 6	28 Mn 6, 35 M 5	28 Mn 6, 150 M 19	SMn 433
1.1178	C 30 E	—	2 C 30, XC 32	S 30 C
1.1181	C 35 E	2 C 35, XC 38 H 1	080 M 36	S 35 C
1.1183	Cf 35	XC 42 TS	080 A 35	S 35 C
1.1186	C 40 E	2 C 40, XC42 H 1	2 C 40, 080 M 40	S 40 C
1.1191	C 45 E	XC 48 H 1, 2 C 45	2 C 45, 080 M 46	S 45 C
1.1193	Cf 45	XC 42 TS	060 A 47	S 45 C
1.1203	C 55 E	2 C 55, XC 55 H 1	2 C 55, 070 M 55	S 55 C
1.1206	C 50 E	2 C 50	2 C 50, 080 M 50	S 50 C
1.1213	Cf 53	42 M 4 TS	060 A 57	S 50 C
1.1221	C 60 E	2 C 60	2 C 60, 060 A 62	S 58 C
1.2241	51 CrV 4	50 CV 4	735 A 51	SUP 10
1.2369	81 MoCrV 42-16	—	—	—
1.3505	100 Cr 6	100 C 6	535 A 99	SUJ 2
1.3520	100 CrMn 6	—	535 A 99	SUJ 3
1.3533	17 NiCrMo 14	16 NCD 13	—	—
1.3536	100 CrMo 7-3	—	—	—
1.3537	100 CrMo 7	100 CD 7	—	SUJ 4
1.3541	X 45 Cr 13	—	—	—
1.3543	X 102 CrMo 17	Z 100 CD 17	—	SUS440 C
1.3551	80 MoCrV 42-16	80 DCV 40	—	—
1.3553	X 82 WMoCrV 6-5-4	Z 85 WDCV 6	BM 2	SKH 51
1.3558	X 75 WCrV 18-4-1	—	BT 1	SKH 2
1.4000	X 6 Cr 13	Z 6 C 13	403 S 17	SUS 410 S
1.4002	X 6 CrAl 13	Z 6 CA 13	405 S 17	SUS 405
1.4005	X 12 CrS 13	Z12 CF 13	416 S 21	SUS 416
1.4006	X 12 Cr 13 (X 10 Cr 13)	10 C 13, Z 12 C 13	410 S 21	SUS 410
1.4007	X 35 Cr 14	—	—	SUS 420
1.4016	X 6 Cr 17	Z 8 C 17	430 S 17	SUS 430
1.4021	X 20 Cr 13	Z 20 C 13	420 S 37	SUS 420
1.4024	X 15 Cr 13	—	403 S 17	—
1.4028	X 30 Cr 13	30 C 13, Z 33 C 13	420 S 45	SUS 420
1.4034	X 46 Cr 13	Z 40 C 14	420 S 45	SUS 420
1.4057	X 20 CrNi 17-2	Z 15 CN 16-02	431 S 29	SUS 431
1.4104	X 12 CrMoS 17	Z 10 CF 17	441 S 29	SUS 430 F
1.4111	X 90 CrMoV 1	—	—	SUS 440 B
1.4113	X 6 CrMo 17-1	Z 8 CD 17-01	434 S 17	SUS 434
1.4125	X 105 CrMo 17	Z100 CD 17	—	SUS 440 C
1.4301	X 5 CrNi 18-10 (X 4 CrNi 18-10)	Z 6 CN 18-09	304 S 16	SUS 304
1.4303	X 5 CrNi 18-12 (X 4 CrNi 18-12)	Z 8 CN 18-12	305 S 19	—
1.4305	X 10 CrNiS 18-9	Z 10 CNF 18-09	303 S 21	SUS 303
1.4306	X 2 CrNi 19-11	Z 2 CN 18-10	304 S 11	SUS 304 L
1.4307	X 2 CrNi 18-9	Z 3 CN 18-10	304 S 11	SUS 304 L
1.4310	X 12 CrNi 17-7	Z 11 CN 18-08	301 S 21	SUS 301
1.4311	X 2 CrNiN 18-10	Z 3 CN 18-10 Az	304 S 61	SUS 304 LN
1.4362	X 2 CrNiN 23-4	Z 3 CN 23-04 Az	—	—
1.4372	X 12 CrMnNiN 17-7-5	Z 12 CMN 17-07 Az	—	—
1.4401	X 5 CrNiMo 17-12-2 (X 4 CrNiMo 17-12-2)	Z 6 CND 17-11	316 S 31	SUS 316
1.4404	X 2 CrNiMo 17-13-2 (X 2 CrNiMo 17-12-2)	Z 2 CND 17-12	316 S 11	SUS 316 L
1.4406	X 2 CrNiMoN 17-11-2 (X 2 CrNiMoN 17-11-2)	Z 2 CND 17-11 Az	316 S 62	SUS 316 LN
1.4410	X 2 CrNiMoN 25-7-4	Z 3 CND 25-06 Az	—	—
1.4418	X 4 CrNiMo 16-5	Z 6 CND 16 05 1	—	—
1.4429	X 2 CrNiMoN 17-13-3	Z 2 CND 17-13 Az	—	SUS 316 LN
1.4432	X 2 CrNiMo 17-12-3	Z 3 CND 17-12-03	316 S 13	SUS 316 L
1.4434	X 2 CrNiMoN 17-12-3	Z 3 CND 19-14 Az	—	SUS 317 LN
1.4435	X 2 CrNiMo 18-14-3	Z 2 CND 17-13	316 S 13	SUS 316 L
1.4436	X 5 CrNiMo 17-13-3 (X 4 CrNiMo 17-13-3)	Z 6 CND 17-12	316 S 33	SUS 316
1.4438	X 2 CrNiMo 18-16-4 (X 2 CrNiMo 18-15-4)	Z 2 CND 19-15	317 S 12	SUS 317 L
1.4439	X 2 CrNiMoN 17-13-5	3 CND 18-14-05 Az	—	—
1.4441	X 2 CrNiMo 18-15-3	Z 3 CND 18-14-13	316 S 13	—
1.4460	X 4 CrNiMoN 27-5-2 (X 3 CrNiMoN 27-5-2)	25 CND 27-05 Az	—	SUS 329
1.4462	X 2 CrNiMoN 22-5-3	Z2 CND 22-05 Az	—	—
1.4466	X 1 CrNiMoN 25-22-2 (X 2 CrNiMoN 25-22-2)	—	—	—
1.4504	[X 8 CrNiAl 17-7]	Z 8 CNA 17-07	316 S 111	17-7 PH
1.4510	X 6 CrTi 17 (X 3 CrTi 17)	Z 8 CT 17	—	—
1.4512	X 6 CrTi 12 (X 2 CrTi 12)	Z 3 CT 12	409 S 19	SUH 409
1.4532	X 7 CrNiMoAl 15-7 (X 8 CrNiMoAl 15-7-2)	Z 8 CNDA 15-7	—	—
1.4540	X 4 CrNiCuNb 16-4	Z 6 CNU 17-04	—	SUS 630
1.4541	X 6 CrNiTi 18-10	Z 6 CNT 18-10	321 S 12	SUS 321

UNI - I	UNE - E	AISI - US	condition	material group
28 Mn 6	28 Mn 6, 36 Mn	1330	var <sup>1</sup>	2-3
2 C 30, 080 M 30	2 C 30	—	var <sup>1</sup>	2-3
2 C 35, C 35	2 C 35, C 35 k	—	var <sup>1</sup>	2-3
C 36	C 38 k	1035	var <sup>1</sup>	2-3
2 C 40, C 40	2 C 40, C 42 k	1040	var <sup>1</sup>	2-3
2 C 45, C 45	2 C 45, C 45 k	—	var <sup>1</sup>	2-3
C 43	C 42 k	1045	var <sup>1</sup>	2-3
2 C 55, C 55	2 C 55, C 55 k	—	var <sup>1</sup>	4-5
2 C 50, C 50	2 C 50, C 55 k	1050	var <sup>1</sup>	2-3
C 48	C 48 k	1050	var <sup>1</sup>	2-3
2 C 60, C 60	2 C 60	—	var <sup>1</sup>	4-5
50 CrV 4	F.1430	6150	var <sup>1</sup>	6-9
—	—	613	var <sup>1</sup>	10-11
100 Cr 6	—	52100	var <sup>1</sup>	6-9
100 CrMo 7	—	A 485/2	var <sup>1</sup>	6-9
—	—	E-3310	var <sup>1</sup>	6-9
—	—	5120	var <sup>1</sup>	6-9
100 CrMo 7	—	A 485/3	var <sup>1</sup>	6-9
X 45 Cr 13	—	—	var <sup>1</sup>	10-11
X 105 CrMo 17	—	440 C	var <sup>1</sup>	10-11
X 80 MoCrV 44	—	—	var <sup>1</sup>	10-11
X 82 WMoV 6 5	—	M2 regular C	var <sup>1</sup>	10-11
X 75 WCrV 18	—	T 1	var <sup>1</sup>	10-11
X5 Cr 13	—	410 S	FE	12
X 6 CrA 13	—	405	FE	12
X 12 CrS 13	—	416	FE	12
X 12 Cr 13	—	410	MA	12
—	—	420	MA	12
X 8 Cr 17	—	430	FE	12
X 20 Cr 13	—	420	MA	12
—	—	403	MA	12
—	—	420	MA	13.1
—	—	420	MA	13.1
X 15 CrNi 16	—	431	MA	13.1
X 10 CrS 17	—	430 F	MA	13.1
—	—	440 B	MA	13.1
X 8 CrMo 17	—	434	MA	13.1
—	—	440 C	MA	13.1
X 5 CrNi 18 10	—	304	AU	14.1
X 8 CrNi 18 12	—	305	AU	14.1
X 10 CrNiS 18 09	—	303	AU	14.1
X 2 CrNi 18 11	—	304 L	AU	14.1
—	—	304 L	AU	14.1
X 12 CrNi 17 07	—	301	AU	14.1
—	—	304 LN	AU	14.1
—	—	—	DU	14.2
—	—	201	DU	14.2
X 5 CrNiMo 17 12	—	316	AU	14.1
X 2 CrNiMo 17 12	—	316 L	AU	14.1
X 2 CrNiMoN	—	316 LN	AU	14.1
—	—	—	DU	14.2
—	—	—	MA	13.1
X 2 CrNiMoN 17 13	—	316 LN	AU	14.1
—	—	316 L	AU	14.1
—	—	317 LN	AU	14.1
X 2 CrNiMo 17 13	—	316 L	AU	14.1
X 5 CrNiMo 17 13	—	316	AU	14.1
X 2 CrNiMo 18 16	—	317 L	AU	14.1
—	—	—	AU	14.1
—	—	316 LVM	AU	14.1
—	—	329	DU	14.2
—	—	2205	DU	14.2
—	—	310 mod	S-AU	14.3
X 2 CrNiMo 17.12	—	17-7 PH	AU-PH	14.4
—	—	439, 430 Ti	FE	12
—	—	409	FE	12
—	—	632	AU	14.1
—	—	630	AU	14.1
X 6 CrNiTi 18 11	—	321	AU	14.1

material number	DIN EN - D	AFNOR - F	BS - UK	JIS
1.4542	X 5 CrNiCuNb 17-4	Z 6 CNU 17-04, Z 7 CNNb 17-07	—	SUS 630
1.4548	X 5 CrNiCuNb 17-4-4	Z 7 CNNb 17-07	—	SUS 630
1.4550	X 6 CrNiNb 18-10	Z 6 CNNb 18-10	347 S 17	SUS 347
1.4552	GX 5 CrNiNb 19-10 (G-X 5 CrNiNb 18-9)	Z 6 CNNb 18.10 M	347 C 17	SCS 21
1.4567	X 3 CrNiCu 18-9 (X 3 CrNiCu 18-9-4)	Z 3 CNU 18-09 FF	—	—
1.4568	X 7 CrNiAl 17-7	Z 8 CNA 17-7	316 S 111	17-7 PH
1.4571	X 6 CrNiMoTi 17-12-2	Z 6 CNDT 17-12	320 S 31	SUS 316 Ti
1.4573	X 10 CrNiMoTi 18-12	Z 6 CNDT 17-13	320 S 33	—
1.4580	X 6 CrNiMoNb 17-12-2	Z 6 CNDNb 17-12	—	—
1.4581	GX 5 CrNiMoNb 19-11 (G-X 5 CrNiMoNb 18-10)	Z 4 CNDNb 18.12 M	318 C 17	SCS 22
1.4583	X 10 CrNiMoNb 18-12	Z 6 CNDNb 17-13	—	—
1.4713	X 10 CrAl 7	Z 8 CA 7	—	—
1.4718	X 45 CrSi 9-3	Z 45 CS 9	401 S 45	SUH 1
1.4720	X 7 CrTi 12	Z 6 CT 12	—	SUS 409
1.4724	X 10 CrAl 13	Z 10 C 13	403 S 17	SUS 405
1.4731	X 40 CrSiMo 10-2	Z 40 CSD 10	—	SUH 3
1.4742	X 10 CrAl 18	Z 12 CAS 18, Z 10 CAS 18	430 S 17	SUS 430
1.4748	X 85 CrMoV 18-2	Z 85 CDV 18.02	—	—
1.4762	X 10 CrAl 24	Z 10 CAS 24	—	SCH446
1.4821	X 20 CrNiSi 25-4	Z 20 CNS 25.04	—	—
1.4828	X 15 CrNiSi 20-12 Z	15 CN 23-13, Z 15 CNS 20-12	309 S 24	SUS 309 S
1.4833	X 7 CrNi 23-14	Z 15 CN 23.13, Z 15 CN 24.13	309 S 16	SUH 309
1.4841	X 15 CrNiSi 25-20	Z 15 CNS 25-20, Z 12 CNS 25-20	310 S 24	SUS310
1.4845	X 12 CrNi 25-21	Z 12 CN 26.21, Z 12 CN 25.20	310 S 31	SUH 310
1.4864	X 12 NiCrSi 36-16	Z 20 NCS 33.16, Z 12 NCS 35.16	—	SUH 330
1.4871	X 53 CrMnNiN 21-9	Z 53 CMN 21.09 Az	349 S 54	SUH 35
1.4873	X 45 CrNiW 18-9	Z 35 CNWS 14.14	331 S 40	SUH 31
1.4875	X 55 CrMnNiN 20-8	Z 55 CMN 20.08 Az	—	—
1.4876	X 10 NiCrAlTi 32-20	Z 8 NC 33.21, Z 8 NC 32.21	—	—
1.487	X 12 CrNiTi 18-9	Z 6 CNT 18.12, Z 6 CNT 18.10	321 S 12, 321 S 51	SUS 321
1.4948	X 6 CrNi 18-11	Z 6 CN 18-09	304 S 51	SUS304
1.5023	38 Si 7	46 S 7	—	—
1.5092	60 SiCr 7	61 SC 7	251 A 61	SUP 7
1.5919	15 CrNi 6	16 NC 6	815 M 17	SNC 15
1.5920	18 CrNi 8	20 NC 6	822 M17	SNCM 616
1.6511	36 CrNiMo 4	36 CrNiMo 4	36 CrNiMo 4, 817 A 37	SNCM 439
1.6580	30 CrNiMo 8	30 CrNiMo 8, 30 CND 8	30 CrNiMo 8	SNCM 630
1.6582	34 CrNiMo 6	34 CrNiMo 6	34 CrNiMo 6, 817 M 40	SNCM 447
1.6587	17 CrNiMo 6	18 NCD 6	820 M 17	SNCM 815
1.7003	38 Cr 2	38 Cr 2	38 Cr 2, 120 M 36	SMn 438
1.7003	46 Cr 2	46 Cr 2, 42 C 2	46 Cr 2, 605 M 36	SMn 443
1.7030	28 Cr 4	30 CD 4	530 A 30	—
1.7033	34 Cr 4	34 Cr 4, 32 C 4	34 Cr 4, 530 A 32	SCr 430
1.7034	37 Cr 4	37 Cr 4, 38 C 4	37 Cr 4, 530 A 36	SCr 435
1.7035	41 Cr 4	41 Cr 4, 42 C 4	41 Cr 4, 530 M 40	41 Cr 4SCr 440
1.7037	34 CrS 4	34 CrS 4, 32 C 4	34 CrS 4, 530 A 32	—
1.7038	37 CrS 4	37 CrS 4, 38 C 4	37 CrS 4, 530 A 36	—
1.7039	41 CrS 4	41 CrS 4, 42 C 4	41 CrS 4, 530 M 40	—
1.7102	54 SiCr 6	51 S 7	251 A 58	SKD12
1.7131	16 MnCr 5	16 MC 5	527 M 17	—
1.7147	20 MnCr 5	20 MC 5	—	SMnC 420
1.7176	55 Cr 3	55 C 3	525 A 60	SUP 9
1.7213	25 CrMoS 4	25 CrMoS 4, 25 CD 4	25 CrMoS 4, 708 A 25	—
1.7218	25 CrMo 4	25 CrMo 4, 25 CD 4	25 CrMo 4, 708 A 25	SCM 430
1.7220	34 CrMo 4	34 CrMo 4, 34 CD 4	34 CrMo 4, 708 A 37	SCM 435
1.7225	42 CrMo 4	42 CrMo 4, 42 CD 4	42 CrMo 4, 708 M 40	SCM440
1.7226	34 CrMoS 4	34 CrMoS 4, 34 CD 4	34 CrMoS 4708 A 37	—
1.7227	42 CrMoS 4	42 CrMoS 4, 42 CD 4	42 CrMoS 4, 708 M 40	—
1.7228	50 CrMo 4	50 CrMo 4	50 CrMo 4, 708 A 47	—
1.7321	20 MoCr 4	—	805 M 20	SNCM 220
1.7325	25 MoCr 4	18 CD 4	—	—
1.7361	32 CrMo 12	30 CD 12	722 M 24	—
1.7701	51 CrMoV 4	51 CDV 4	—	SUP 13
1.8159	51 CrV 4	51 CrV 4, 50 CV 4	51 CrV 4	SUP 10
1.8507	34 CrAlMo 5	—	—	—
1.8509	41 CrAlMo 7	40 CAD 6 12	905 M 39	—
1.8515	31 CrMo 12	30 CD 12	722 M 24	—
1.8523	39 CrMoV 13-9	—	897 M 39	—
1.8550	34 CrAlNi 7	—	—	—

UNI - I	UNE - E	AISI - US	condition	material group
—	—	630	AU-PH	14.4
—	—	630	AU-PH	14.4
X 8 CrNiNb 18 11	—	347	AU	14.1
—	—	—	AU	14.1
—	—	302 HQ	AU	14.1
X 2 CrNiMo 17.12	—	17-07 PH	AU-PH	14.4
X 6 CrNiMoTi 17 12	—	316 Ti	AU	14.1
X 6 CrNiMoTi 17 12	—	(316 Ti)	AU	14.1
X 6 CrNiMoNb 17 12	—	316 Cb	AU	14.1
GX 6 CrNiMoNb 20 11	—	—	AU	14.1
X 6 CrNiMoNb 17 13	—	316 Cb, (318)	AU	14.1
—	—	—	FE	10–11
X 45 CS 8	—	HNV 3	—	31–32
—	—	409	—	31–32
X 10 CrAl 12	X 10 CrAl 13	405	FE	12
—	—	—	—	12
X 8 Cr 17	X 10 CrAl 18	430	—	12
—	—	—	—	31–32
X 16 Cr 26	—	446	—	12
—	X 15 CrNiSi 25 04	—	DU	14.2
—	X 10 CrNiSi 20	309	AU	14.1
X 6 CrNi 23 14	—	309 S	AU	14.1
X 16 CrNiSi 25 20	X 15 CrNiSi 25 20	310	AU	14.1
—	—	310 S	AU	14.1
—	X 12 NiCrSi 36 16	330	—	31–32
—	—	EV 8	—	10
X 45 CrNiW 18 9	—	EV 9	—	31–32
—	—	EV 11	—	31–32
—	X 10 NiCrAlTi 32 20	—	S-AU	31–32
X 6 CrNiTi 18 11	—	321, 321 H	—	31–32
—	—	304H	AU	14.1
—	—	—	var1	6–9
60 SiCr 8	F.1442	9260	var1	6–9
—	F.1581	4320	var1	6–9
16 NiCrMo 12	F.1525	—	var1	6–9
36 CrNiMo 4, 39 NiCrMo 3 1	36 CrNiMo 4, 40 NiCrMo 4	—	var1	6–9
SNCM 630	30 CrNiMo 8, 32 NiCrMo 16	—	var1	6–9
34 CrNiMo 6	34 CrNiMo 6	4340	var1	6–9
18 NiCrMo 12	F.1560	—	var1	6–9
38 Cr 2	38 Cr 2, 38 Cr 3	—	var1	6–9
46 Cr 2	46 Cr 2	—	var1	6–9
—	—	—	var1	6–9
34 Cr 4	34 Cr 4	5132	var1	6–9
37 Cr 4	37 Cr 4, 38 Cr 4	5135	var1	6–9
41 Cr 4	41 Cr 4, 42 Cr 4	5140	var1	6–9
34 CrS 4	34 CrS 4	—	var1	6–9
37 CrS 4	37 Cr 4, 38 Cr 4-1	—	var1	6–9
41 CrS 4	41 CrS 4, 42 Cr 4-1	—	var1	6–9
48 Si 7	F.1450	9260	var1	6–9
16 MnCr 5	F.1516	—	var1	6–9
20 MnCr 5	F.1523	—	var1	6–9
55 Cr 3	—	5155	var1	6–9
25 CrMoS 4, 25 CrMo 4	25 CrMoS 4, 30 CrMo 4-1	—	var1	6–9
25 CrMo 4	25 CrMo 4, 30 CrMo 4	4130	var1	6–9
34 CrMo 4, 35 CrMo 4	34 CrMo 4, 35 CrMo 4	4137	var1	6–9
42 CrMo 4	42 CrMo 4	—	var1	6–9
34 CrMoS 4, 35 CrMo 4	34 CrMoS 4, 35 CrMo 4	—	var1	6–9
42 CrMoS 4, 42 CrMo 4	42 CrMoS 4, 40 CrMo 4-1	—	var1	6–9
50 CrMo 4	50 CrMo 4	4150	var1	6–9
16 NiCrMo 2	F.1523	8620	var1	6–9
20 NiCrMo 2	—	8625	var1	6–9
—	—	—	var1	6–9
51 CrMoV 4	—	—	var1	6–9
51 CrV 4, 50 CrV 4	51 CrV 4	6150	var1	6–9
—	35 CrAlMo 5	A 355/D	var1	6–9
41 CrAlMo 7	41 CrAlMo 7	A 355/A	var1	6–9
31 CrMo 12	31 CrMo 12	—	var1	6–9
36 CrMoV 12	—	—	var1	6–9
—	—	A 355/C	var1	6–9